

A Robotic System for Monitoring Carp in Minnesota Lakes

Pratap Tokekar

Department of Computer Science
University of Minnesota
Minneapolis, MN 55455
tokekar@cs.umn.edu

Andrew Studenski

Department of Computer Science
University of Minnesota
Minneapolis, MN 55455
studen@cs.umn.edu

Deepak Bhadauria

Department of Computer Science
University of Minnesota
Minneapolis, MN 55455
bhadau@cs.umn.edu

Volkan Isler

Department of Computer Science
University of Minnesota
Minneapolis, MN 55455
isler@cs.umn.edu

Abstract

Robotic Sensor Networks (RSNs) find increasing use in environmental monitoring as RSNs can collect data from obscure, hard-to-reach places over long periods of time. This work reports progress in building a network of small, light-weight robotic rafts which will be used to monitor common carp tagged with radio transmitters across Minnesota lakes. We describe the design and architecture of the robotic raft, and demonstrate the robustness of our waypoint navigation algorithm through field tests conducted in various lakes. We also present results from experiments aimed towards localizing tagged fish.

1 Introduction

A Wireless Sensor Network (WSN) is a network of inexpensive, low-power computing devices with sensing and wireless communication capabilities. WSN research has been very active in the last two decades with

researchers focusing on issues such as the development of energy-efficient communication protocols to improve network lifetime (Akkaya and Younis, 2005). Consequently, the technology advanced to the level that WSNs are now being routinely used in environmental applications such as monitoring of humidity levels to determine vineyard irrigation levels (Network World, 2009).

Environmental monitoring is an important application domain for WSN technology as a WSN enables collection of data at unprecedented spatial and temporal scales. This capability is crucial to understand complex phenomena which, in turn, is invaluable for scientists tackling critical environmental issues. Unfortunately, it is very difficult to deploy and maintain networks of stationary sensors over large areas. As an example, consider the task of monitoring carp in Minnesota's 10,000+ lakes. These lakes vary in size and some are interconnected, forming complex interactions. The common carp is recognized as an invasive species to the



Figure 1: The raft during field trials at Lake Phalen. A directional loop antenna which records signals from radio tagged fish is attached to a pan-tilt unit on top of the raft.

waters of the Midwestern United States. Carp pose a significant threat to natural ecosystems due to the large quantities of harmful nutrients which they release while bottom-feeding. It is for this reason that understanding and monitoring carp populations has garnered increased interest in areas with significant carp infestations, such as the lakes of Minnesota. Professor Peter Sorensen, a leading expert of fish behavior with the Department of Fisheries, Wildlife, and Conservation Biology at the University of Minnesota, is dedicated to tracking and controlling the species.

In order to study fish behavior, researchers in Sorensen Lab tag carp with radio transmitters. The fish are

caught and transmitters are surgically inserted under their skin before they are reintroduced back into the lake, a process which takes considerable time and effort. These tags emit short regular pulses which can be heard up to 50 meters under ideal conditions. Collecting data then requires the work of two lab members: one to steer a boat toward locations where the fish are likely to be found, and the other to operate the antenna and receiver units. The process of actually locating a fish requires the latter lab member to rotate a directional antenna, give directions to the other lab member and record measurements from GPS and antenna simultaneously. Consequently, data collection is usually imperfect and can be performed only for a limited duration. Yet, Dr. Sorensen's group is often interested in determining carp distributions at obscure places and times such as shallow wetlands where carp can migrate and reproduce. Sometimes the data is required to be collected at odd hours, for example during daybreak, a time which is prohibitively cold in Minnesota weather. The ability to continuously monitor the lakes without manual involvement would thus prove useful.

We are collaborating with Sorensen Lab to automate the data collection process. At first, one might think that a network of stationary antenna would be suitable for this task. However, a data logger, receiver and antenna combination costs about \$3,000, and has a range of roughly 50 meters. Therefore, even covering a single lake could be costly. Even though deploying a stationary network may be feasible for one lake, deploying such networks across numerous interconnected lakes around the Twin Cities would be prohibitively costly. We believe that a network of a small number of light-weight robotic rafts could be ideal for this task. Such a network can be easily deployed and it can autonomously reconfigure itself based on the location of the tagged fish. We recently started building a robotic raft for monitoring carp in Minnesota Lakes (Figure 1). In this paper, we present our current design, and report results from the first set of field experiments which demonstrate the utility of the system.

The rest of the paper is organized as follows: The related work in marine robotic systems is presented in Section 2. Section 3 gives details about the raft's hardware design and system architecture. The navigation algorithms are described in Section 4. Field experiments for autonomous waypoint navigation, fish detection and fish localization are presented in Section 5. Finally, we conclude by presenting an overview of future work in Section 6.

2 Related Work

Marine robotics has seen significant activity in the past few years. Numerous groups across the world are involved in designing and developing marine robotic systems for various applications such as environmental monitoring. An Autonomous Surface Vehicle (ASV) named ROAZ (Ferreira et al., 2006) was developed for operation in rivers and estuaries. The main objective was to perform aquatic environmental monitoring and to support operations of other underwater vehicles. Another ASV developed at Virginia Tech (Subramanian et al., 2006) was used for mapping shorelines. Researchers at University of South Florida developed unmanned surface vehicle with autonomous and tele-operated control (Steimle and Hall, 2006) for testing and deploying environmental and oceanographic instrumentation. Higinbotham et al. are working towards developing a solar-powered ASV (Higinbotham et al., 2008) for long term operation to collect oceanographic and atmospheric data. Caccia, Bibuli, Bono and Bruzzone, describe the navigation and control algorithms for their prototype unmanned surface vehicle Charlie in (Caccia et al., 2008).

In parallel to surface-based systems, underwater autonomous systems have garnered a significant amount of attention. Consequently the designs of such systems are improving rapidly (see the survey: (Blidberg, 2001)). Tantan (Kumagai et al., 2002) is an Autonomous Underwater Vehicle (AUV) developed to monitor the quality of water in lakes. It carries multiple sensors to monitor the distribution of plankton and measure the level of dissolved oxygen in the water. The AUV Sirius (Williams et al., 2009) from the Australian Center for Field Robotics is equipped with a high-resolution stereo-imaging system. The AUV was used to obtain images to study the nocturnal camouflage behavior in cuttlefish through various short missions over 6 nights. SAUVIM (Marani et al., 2009) is an AUV with manipulation capabilities which can be used for autonomous intervention especially in dangerous and hazardous conditions.

Recently, researchers have focused on developing systems with one or more AUVs or ASVs working together with sensor nodes already deployed in the water. The system developed by CINAPS at University of Southern California consists of stationary sensor bouys deployed in the water, and robotic boats and underwater gliders to collect data from the bouys (Smith et al., 2010). The sensors collect data regarding harmful algal bloom and other water quality parameters. AMOUR V (Vasilescu et al., 2010) is an AUV developed at MIT which communicates with underwater sensor nodes. It is capable of controlling its bouyancy in the presence of dynamic payloads. Cooperative control algorithms for a system comprising of the AMOUR and Starbug AUVs (Dunbabin et al., 2005) from CSIRO and sensor nodes are proposed in (Dunbabin et al., 2009). Algorithms for docking and cooperative motion control are presented.

The system presented in this paper is designed to address two primary issues. Minnesota has a large number of lakes interconnected through streams and rivers. Researchers desire to track carp across the entire watershed, therefore the system should be rapidly deployable, and thus be small and lightweight (ideally it should fit within a car). Second, the cost of the system should be low, so that we can build multiple such rafts. Most of the systems mentioned above are large in size (in fact, they require special deployment equipment) and expensive.

The system described in (Sukhatme et al., 2007) is closest to our system in design. It consists of a number of stationary buoys deployed in a lake along with a robotic boat capable of autonomous navigation. The buoys continuously monitor the environment and communicate collected sensor information to the boat. The boat also samples the water body using on-board sensors. Our system differs from this system in that, as previously mentioned, we cannot deploy static nodes as the cost scales to prohibitive levels in larger implementations. Additionally, instead of collecting environmental data relative to the lake itself, we focus on mobile entities inside the lake for which new searching and tracking algorithms must be developed.

Radio telemetry and acoustic telemetry are the two primary methods used in fish tracking applications. Since the high attenuation of radio signals in seawater renders radio telemetry ineffective, acoustic telemetry is the only choice in most marine applications. On the other hand, the acoustic conditions in shallow waters with boating activity adversely affect the detection capabilities of acoustic devices. In general, the choice of acoustic versus radio telemetry depends on numerous factors such as tag power, conductivity, tag depth, and antenna type in addition to environmental factors. A detailed comparison of radio and acoustic tag detection performance specifically in Minnesota waters can be found in (Shroyer and Logsdon, 2009).

3 Design

The following subsections describe the design goals and the resulting implementation for the main components of the robotic raft.

3.1 Physical System Design

Development of the physical system was largely constrained by the system used to track carp which was already operating in the field. Researchers in Sorensen Lab trap carp from specific bodies of water, tag them

with radio frequency transmitters, and release them back into the lake. A directional antenna system with limited range (see Section 3.2.5 for details) is used to detect the carp's location.

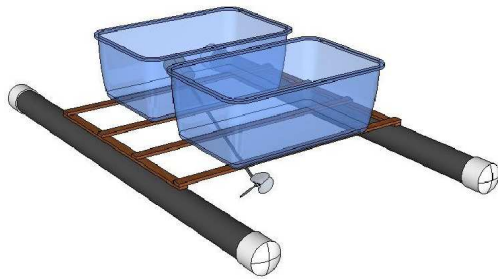

(a) 3D model of the raft. The raft has a length of 5 feet and width of 3 feet.

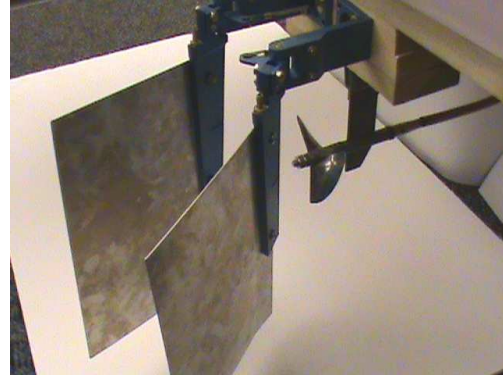

(b) Rudder and Propeller assembly. The two rudders are connected together to a servo motor. The propeller connects to DC motor through a flexible shaft.

Figure 2: Design of the raft.

We decided to use a single catamaran style craft as shown in Figure 2(a). For transportation purposes the raft was designed to be light-weight and sturdy as well as small enough to fit inside a regular-sized automobile. Additionally, the raft was required to produce enough buoyant force to support up to 20kgs of electronic equipment and its waterproof casing, with adequate propulsion and maneuverability to reliably move the payload around the lake.

In order to keep the cost of the raft at a minimum, the design incorporated existing commercially available materials instead of custom made parts. Two 5 feet sections of 4 inch construction grade polyvinyl chloride (PVC) pipe provide the necessary buoyancy force for the raft. Several thin planks of wood are used to form the light weight and sturdy frame on which the PVC pipes are securely fastened. Two plastic bins are placed over the frame. The electronics and on-board laptops are placed inside these bins. We use a 3 inch diameter 3-blade propeller attached to a 12 volt DC motor through a flexible shaft for the propulsion of the raft, shown in Figure 2(b). The steering comes from two modified hobby boat rudder assembly connected to a single servo motor. The forward speed of the raft is controlled by the DC motor. The rotational velocity of the raft is controlled using the servo angle, similar to car-like robots. A 12 volt, 18Ah sealed lead-acid battery is used as the main power source for steering and propulsion. This battery provides 5 hours of continuous operation.

3.2 System Architecture

The system architecture was developed keeping in mind the following design goals and requirements:

- Modular design: High-level functionality such as navigation, localization, and data logging are separated from low-level device control such as driving the propeller, steering, and operating the pan-tilt unit. This allows flexibility in adding new components to the system and modifying the existing ones without affecting the other components.
- Remote access: User should be able to monitor the data collection and set navigation waypoints for the raft remotely. In metro area lakes, often wireless Internet access is available. The raft can connect to the Internet which allows remote operation and visualization.
- Optional manual override: selective radio control over steering and propulsion. This is required in case of emergency situations, where the user wants to override the navigation algorithm running on raft and take direct control of the rudder and propulsion.

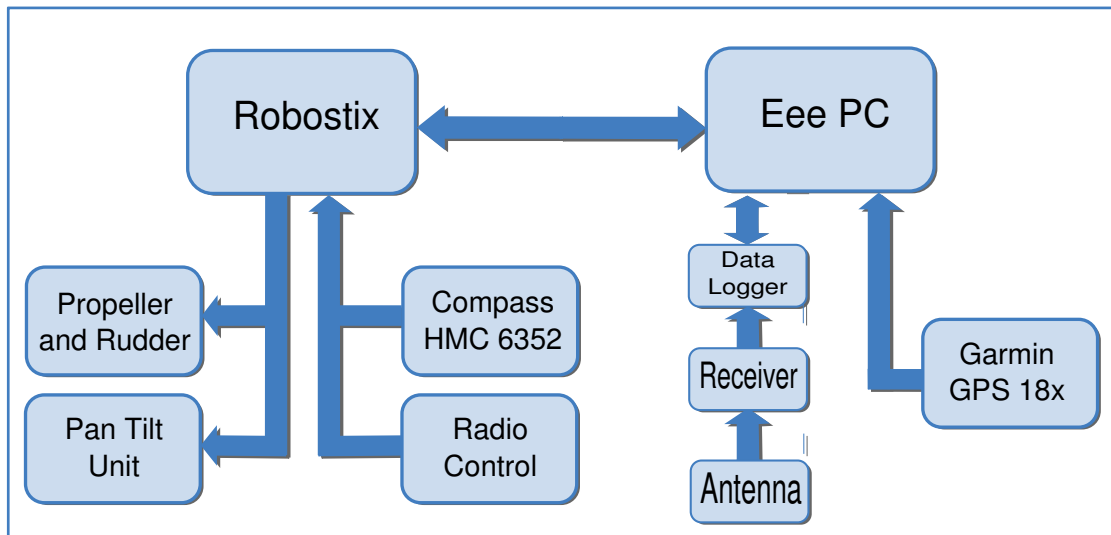

Figure 3: Overall System Architecture. The low-level control software runs on the Robostix microcontroller. The Eee PC controls the radio antenna and runs the high-level navigation routines.

With these goals in mind, a two-level system was devised (see Figure 3): low-level control is provided by the Robostix 8-bit microcontroller board while high-level software runs on an on-board netbook. The Robostix connects to the drivers for the propeller and rudder motors. The antenna is mounted on a pan-tilt unit to make use of the directionality of the antenna. The Robostix runs the low-level control software for the pan-tilt unit. A 4-channel FM radio controller (used in RC helicopters) is used to provide optional manual override

in case of emergency. The on-board netbook interfaces with the data logger and antenna equipment. We use GPS sensor and a digital compass for autonomous navigation. We describe the each of these components in the following subsections.

3.2.1 Eee PC

The Eee PC netbook from ASUS, running Linux, is the main computer on the raft. The software running on the Eee PC manages high level motion planning and continuously reads the data from all the sensors. GPS data is collected directly from the Garmin 18x GPS unit attached via USB. Data from the radio antenna and receiver is recorded via the data logger unit over USB. The compass readings are obtained from the Robostix unit at regular intervals during execution. All the received data is logged for offline usage. Additionally, the on-board Eee PC software is responsible for executing the motion control algorithm (see Section 4). We can connect to the on-board Eee PC over a remote ssh connection using another laptop from the shore. This allows us to monitor the current data or modify the running program remotely without removing the raft from the water.

3.2.2 GPS

The Garmin 18x GPS receiver interfaces with the Eee PC through a USB port. The GPS refreshes and receives a new reading once every second. The WAAS-enabled GPS is rated for error less than 3 meter. In addition to latitude, longitude and altitude readings, the GPS also transmits the velocity in the North and East directions. The track of the robot, H_{gps} , can be calculated using the velocity values using,

$$H_{gps} = \tan^{-1}\left(\frac{v_N}{v_E}\right) \quad (1)$$

where v_N and v_E are the velocity values in North and East directions obtained from GPS.

3.2.3 Microcontroller

The Robostix is a commercially-available, ATMEL ATmega128 based microcontroller board from Gumstix. It acts as the low-level controller and generates signals to drive the propeller motor and rudder servo motor. It also reads the current heading of the raft from the on-board compass using the I2C protocol. Additionally, the Robostix controls the pan and tilt servo motors on which the antenna is mounted. A separate 7.2V 4200mAh NiMh battery is used to power the Robostix and the compass.

The Robostix interfaces with the Eee PC through a USB to serial connection. To control the propeller speed and the rudder angle, the Eee PC sends commands to the Robostix, which then takes the corresponding action. The Robostix also sends the latest compass reading, when requested by the Eee PC. As a safety feature, three channels from the 4-channel FM radio receiver are connected to Robostix. The Robostix continuously monitors one of the channels to see if the Radio Override signal is being sent from the user operated radio control unit. If this channel is active, commands from the Eee PC are ignored and the user can directly control the propeller and rudder using the two remaining radio frequency channels. Once the user stops sending the override signal on this channel, the control is transferred back to the Eee PC.

3.2.4 Compass

The Honeywell HMC6352 compass module from SparkFun Electronics is used on the raft to provide the heading angle information. The compass is rated to give heading resolution of $0.5^\circ/s$ and an accuracy of $2.5^\circ/s$. The compass combines two magneto-resistive sensors to sense the horizontal components of earth's magnetic field to compute the heading information.

3.2.5 Radio Tags, Receiver and Data Logger



Figure 4: The transmitter used for tagging fish. It is 85mm long and 15mm in diameter. Image from ATS Track.

Researchers in Sorensen Lab use the radio tag equipment manufactured by Advanced Telemetry Systems (ATS). The complete system consists of radio tags, a loop antenna connected to a radio receiver and a data logger which provides the computer interface for the receiver. The radio tags shown in Figure 4 are 85mm long and 15mm in diameter and have a trailing whip antenna. They use internal lithium battery as the power source. To conserve power, these tags typically emit a pulse for 20ms every 1100ms. Each tag emits a single frequency, hence, when multiple tags are to be used within the same lake, tags with different frequencies

are used. The receiver scans for each of these frequencies and can uniquely identify any detected tag. Since each tag emits a pulse every 1100ms, the antenna has to continuously scan for this frequency for a time greater than 1100ms to detect the presence/absence of the tag. We use tags which operate in the range of 48-50MHz.

A loop antenna is used to detect the signal emitted by the radio tags. The antenna has directional sensitivity. The received signal strength is highest when the radio tag is aligned with the plane of the loop antenna. It is lowest when the antenna is perpendicular to the direction of radio tag and decreases along the way. Hence, we can estimate the bearing of the tag by panning the antenna in a complete circle and noting the signal strength readings. The direction with the maximum signal strength reading points towards the location of the tag. The antenna shows similar signal strength characteristics if the tag lies on either side of the antenna along a straight line, and hence only a scan of 180° is required, since the other half is symmetric

The Data Logger (D5401A) connects to the Eee PC using a USB connection. It provides a programmable interface for connecting to the receiver (R2100). The Data Logger has memory for four frequency tables each capable of storing up to 100 frequencies. The software running on the Eee PC stores a preset frequency list depending on the lake, into this table. The scanning interval of the receiver can also be set by the Eee PC using the Data Logger. Once the receiver is enabled, the Data Logger stores the data in its memory, which can be read by the Eee PC. The stored data includes scanning frequency, received signal strength and a timestamp.

4 Navigation Algorithms

The raft uses on-board GPS and compass sensors as feedback for navigation. GPS gives the position in terms of latitude and longitude and the heading of the raft can be obtained from the compass and the GPS velocity values. Our initial testing of the GPS revealed that the error in velocity values is very large when the raft is stationary. However, when the GPS is moving, the magnitude of error reduces and the velocity values are much more reliable. The digital compass, on the other hand, is affected by magnetic fields in its vicinity, including those generated by the on-board electronic circuitry. In addition, the compass is also affected by tilt. However, we found that a simple moving average filter gave acceptable performance in practice. Instead of relying on only one sensor, for computing the heading of the raft $H_{heading}$, we take a weighted average of

the compass reading H_{comp} and the track obtained from GPS velocity H_{gps} .

$$H_{heading} = \beta H_{comp} + (1 - \beta) H_{gps}. \quad (2)$$

where β is the weighting factor, which can be set as per the confidence for each sensor. A probabilistic filter can be used instead of weighted average, for combining the two sensor readings. The weighted average approach, however, does not require the knowledge of error distribution of GPS and compass. We found that the weighted average approach work effectively for a wide choice of weights. The position information is directly obtained from the GPS.

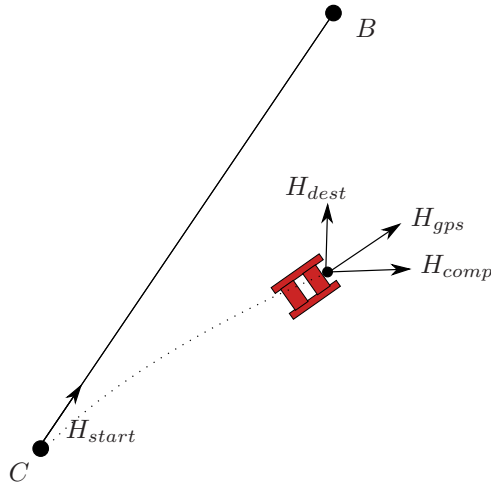

Figure 5: Waypoint navigation between points A and B. H_{gps} is the track obtained from the GPS and H_{comp} is the heading obtained from the compass. H_{comp} is shown with slight error with respect to true heading of the raft. H_{dest} is the desired heading.

A simple control algorithm is used to generate the steering angle θ for the raft. The propeller is always set to move in the forward direction. While going from starting point A to destination point B, the angle by which the raft should steer depends upon the current heading of the raft $H_{heading}$ (given in Equation 2), the angle made by the line AB, denoted by H_{start} and the angle made by the line joining the current position of the raft to the destination position, called H_{dest} . The desired change in the heading, ΔH , of the raft is then given by,

$$\Delta H = \alpha(H_{start} - H_{heading}) + (1 - \alpha)(H_{dest} - H_{start}) \quad (3)$$

$$\theta = k_p \Delta H \quad (4)$$

where α is a weighting factor. The first term in Equation 3 gives the error between the starting heading and the current heading, where as the second term calculates the error between the current heading and

the desired heading. The steering angle θ is set proportional to the error ΔH . The weighting factors α , β and the constant of proportionality, k_p can be determined experimentally. During the experiments, it was found that the GPS and compass readings occasionally had large errors. However, these errors did not last long. For example, when the raft is stationary, the GPS heading values have high error. The error reduces significantly as soon as the raft starts moving. As a result, changing the weighting factors does not change the behavior of the system significantly in the long run. We set the values of α and β to be 0.5 each, after initial testing.

The waypoint navigation algorithm was designed so as to perform in the case of the raft drifting from its course due to waves from other boats in the lake and wind. Such waves and wind can potentially throw the raft off the straight line which would require large error correction. To deal with such cases, we constantly check to see if the raft is within a particular band drawn about the line AB . If the raft drifts outside of this band on either side, we make a new call to the method with the current position and heading of the raft as the starting point towards the same destination.

We call the above method repeatedly when navigating on a series of waypoints, for each consecutive pair of waypoints. Since the GPS location information has some error, we check if the raft has reached the destination by checking if it is within a certain radius from it. This distance was set to be 3 meters which is the specified error for the Garmin GPS 18x. The algorithm terminates when the raft reaches the final waypoint. Additionally, for all waypoints other than the final, we also check if the raft has gone past the waypoint by checking if it has crossed the perpendicular to the line it is following for the current pair of waypoints. We make a new call with the next pair of waypoints if the raft has crossed this line.

5 Field Experiments

The basic physical structure of the raft was initially tested for buoyancy and payload bearing capacity in an indoor tank. The raft was able to carry a payload of 20kgs. We conducted several trials at Spoon Lake, Lake Keller, Lake Riley and Lake Phalen around Minneapolis, MN to test the steering and propulsion on the raft. A safety rope was attached to the raft during the early trials for testing maneuverability of the raft. The raft was controlled manually from the shore using the FM radio control unit. These trials were helpful in improving the rudder assembly for better steering. After successfully completing the maneuverability test, we conducted a number of trials to test autonomous navigation and control of the raft. These tests were

conducted fully autonomously without the safety rope. The details about these trials is presented below ¹.

5.1 Autonomous Waypoint Navigation

The trials for testing autonomous waypoint navigation were performed in Lake Keller in Maplewood, MN. This lake is about 966 meters along its length. The waypoint navigation algorithm was given a series of GPS coordinates within the lake to visit in sequence for each trial. The waypoints were predefined before the trials. The results for three such trial are shown in Figures 6(a), 6(b) & 8(a). For the trial shown in Figure

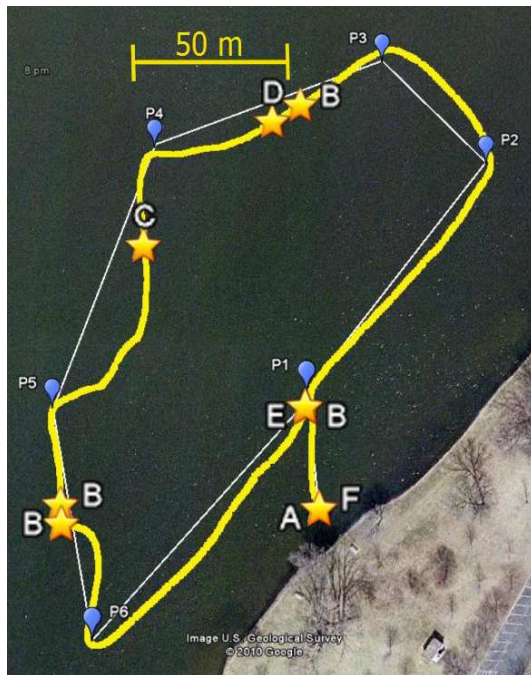

(a) Labels P_1 to P_6 are waypoints. The GPS trail is marked in yellow along with the reference trajectory in white. Star indicates the GPS location where the tagged fish were detected. The total path length was about 540m and was covered in 16 minutes.



(b) Of the 6 tagged fish detected in the trial shown in Figure 6(a), only 2 (B, D) were detected once in this trial, conducted in the same area about 20 minutes later.

Figure 6: Field Experiments at Lake Keller.

6(a), positions marked by labels P_1 to P_6 were the waypoints to be visited by the raft before coming back to P_1 again. The path followed by the raft, obtained from the on-board GPS is shown. The raft successfully visited each of the waypoints in succession. The motion between two successive waypoints is smooth and straight most of the times. For the path between waypoints P_4 to P_5 and between P_5 to P_6 the raft moved away from the straight line initially. This could be attributed to large waves from other boats in the lake causing the raft to drift aside. However, the correction routine checked that the raft was outside of the

¹See also the accompanying video submission (also available at http://rsn.cs.umn.edu/index.php/Environmental_Monitoring).

defined band and ensured that the raft stayed on course. The total distance traveled by the raft in this trial was about 540 meters. This distance was covered in 16 minutes.

We conducted similar trials in different parts of the lake. The GPS trial for two such trials is shown in Figures 6(b) & 8(a). The total distance covered for the path shown in Figure 6(b) was 445 meters in 14 minutes, whereas for the path in Figure 8(a), 304 meters were covered in 16 minutes. The minor deviations from the straight line in Figure 6(b) are again due to disturbance from other boats nearby. After the trials were conducted, we looked at the logged data from the sensors offline and found that the data from the compass was incorrect for some locations. However, since the waypoint navigation algorithm uses bearing information from the GPS in addition to that from compass, the raft did not steer off course at such locations and corrected itself.

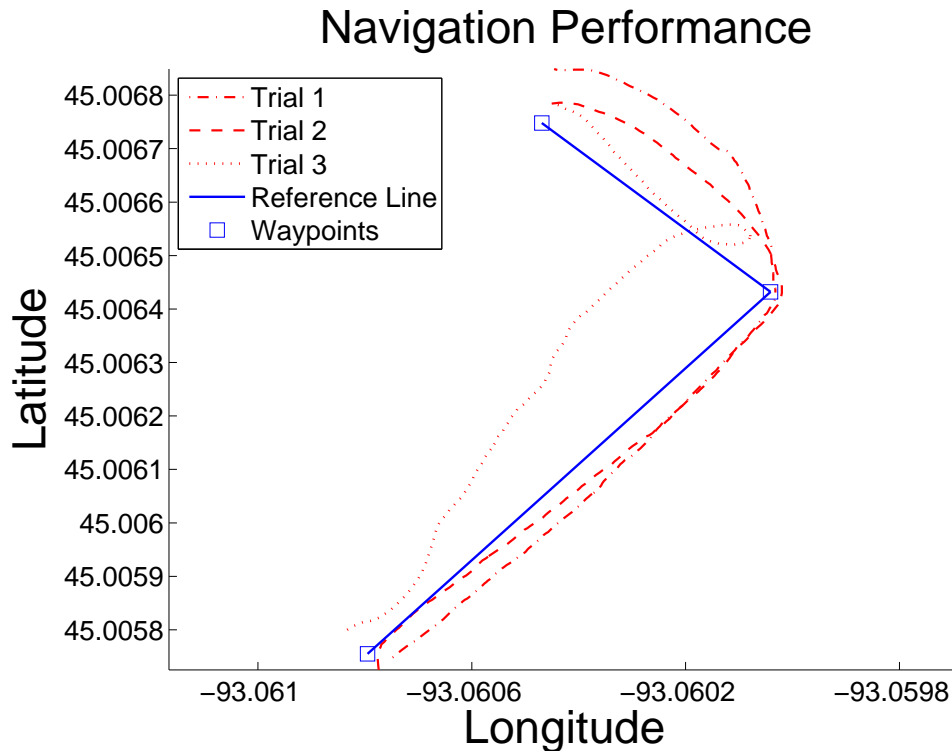

Figure 7: Performance of the waypoint navigation algorithms for 3 trials along the same set of waypoints in different conditions. Trial 1 and 2 were conducted on different days, whereas trial 3 was conducted with water skiers operating close to the raft.

Figure 7 shows the actual path followed by the robot along with the reference trajectory for the same set of waypoints. These trials were conducted on two separate days. Trial 3 was conducted with fast-moving water skiers operating close to the raft. This caused the raft to deviate away from the reference trajectory. The

average error and the standard deviation for the 3 trials is given in the Table 1. The error for each point is the distance of that point from the reference line.

	Average error (m)	Standard deviation (m)
Trial 1	3.0305	3.0621
Trial 2	2.3678	2.3597
Trial 3	11.9333	9.9940

Table 1: Performance of the waypoint navigation algorithm for the three trials shown in Figure 7. The error for each point is the distance of that point from the reference line.

Under normal conditions (trial 1 and 2), the average deviation from the reference line is low and acceptable. For trial 3, the large waves from the water skiers and boats operating close to the raft caused it to continuously drift in the direction of the waves. This caused the deviation to be high and the steering control reach near saturation. This prevented the raft from going closer towards the reference line.



(a) The GPS trail is made in yellow along with the reference trajectory in white. The total distance covered from the first to the last waypoint was about 304m in 16 mins.



(b) All the trials were conducted in natural, uncontrolled environments. There were other boats and water-skiers in the lake.

Figure 8: Field Experiments at Lake Keller.

We conducted more such trials for testing the waypoint navigation algorithm. The raft successfully completed the trials in each case in a robust fashion. All the experiments were conducted in natural, uncontrolled environment with other boats operating in the vicinity of the raft.

5.2 Fish Detection

During the trials for testing the waypoint navigation algorithm, we also tested the radio receiver and data logger. There are 22 fish in Lake Keller tagged with radio transmitters. The data logger was configured to scan for all the 22 frequencies and record the data while performing the trials. A number of tags were detected during these trials. The location of the raft where the tags were detected is marked with star in Figures 6(a) and 6(b). The labels on the stars correspond to the frequency of the radio tag; each label corresponds to a distinct frequency detected at multiple locations.

During one of the early trials, the propeller of the raft suffered mechanical damage and the raft was left stationary at a location for about 30 minutes. During this time, a total of 5 different frequency tags were detected, out of which the tag with frequency 48.691 MHz was detected thrice for 5 minutes and was not detected at later times. This suggests that the fish were moving in this period and would require sophisticated strategy to track and localize them.

These results demonstrate the capability of the system to detect the presence and absence of tagged fish in the radio range of the antenna. While this is certainly useful in finding which part of the lake the fish are present, the radio range could be as large as 50 meters. Our main objective is to be able to precisely locate these fish. To achieve this, it is important to understand the behavior and characteristics of the radio tags and antenna.

5.3 Fish Localization

In addition to detecting the signals from the radio transmitters, the radio receiver provides the signal strength measured by the antenna for that signal. As previously mentioned, the antenna used on the raft to detect the signal is directional i.e., the strength of the signal received from the tag varies as per the relative angle (bearing) between the tag and the antenna. The signal strength is maximum when the antenna is directly pointing towards the tag. This signal strength and bearing information can be used to calculate a more precise location of a tagged fish.

5.3.1 Using Signal Strength

To understand the relationship between signal strength and detection distance, we conducted a set of experiments at Lake Riley in Eden Prairie, Minnesota. A reference frequency tag was inserted under the water

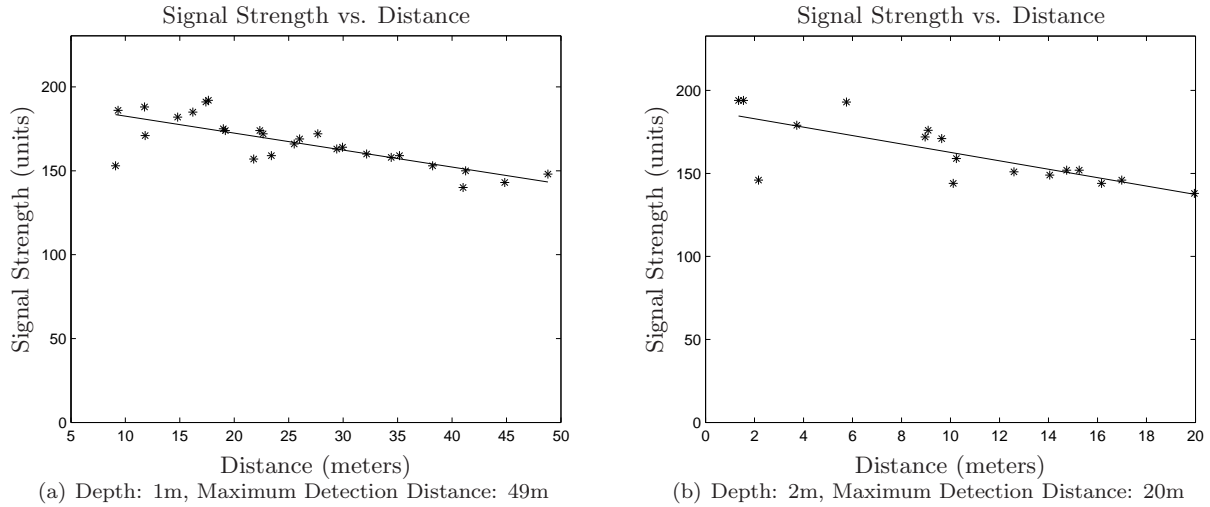

Figure 9: Plot of signal strength vs. distance with least squares linear fit. A reference tag was immersed at different depths under water and the corresponding signal strength was measured by moving the raft along a straight line away from the tag.

in the middle of the lake at a depth of about 1 meter. The raft was directed in a straight line away from the tag, with the antenna was always pointing towards the tag (i.e. the received signal strength was always at the maximum for the directional antenna). The plot of the observed readings with respect to distance is shown in Figures 9(a) for a depth of 1 meter. The maximum distance from the tag up to which the signal was received for this trial was approximately 49 meter. It can be observed that the the signal strength decreases with respect to distance, in general. However, this relation is also a function of the depth of the tag in the water. We repeated the same experiment varying the tag depth to 2 and 4meters. The plots for the experiment with depth of 2 meter is shown in Figures 9(b). For the depth of 2 meters, the tag was only detected up to a distance of 20 meters, while for the depth of 4 meters, this distance further reduced to 10 meters. This makes performing localization using just signal strength measurement from one location very difficult as the depth of the fish is not known. It is clear from these results, that signal strength alone cannot be used to localize the fish.

5.3.2 Triangulation using Bearing

Since the directional antenna provides bearing information, we can use bearings from multiple locations to localize the fish. We performed a triangulation experiment with the reference tag in Lake Keller. The reference tag was suspended in the water at the location marked "Tag" in Figure 10. The raft visited three pre-defined locations marked *A*, *B* and *C* in sequence. At each location, the pan unit was instructed to rotate from 0° to 180° in steps of 45° yielding a total of 5 readings. Since the antenna is bidirectional

(i.e., a reading at $+90^\circ$ also corresponds to a reading at -90°) these readings make a complete sweep in all directions. Out of these readings, the bearing with maximum signal strength is chosen as the direction towards the tag. Using the 3 bearings obtained from A , B and C we can perform triangulation to calculate the location of the tag. The triangulation performed for one such trial is shown in Figure 10. The lines

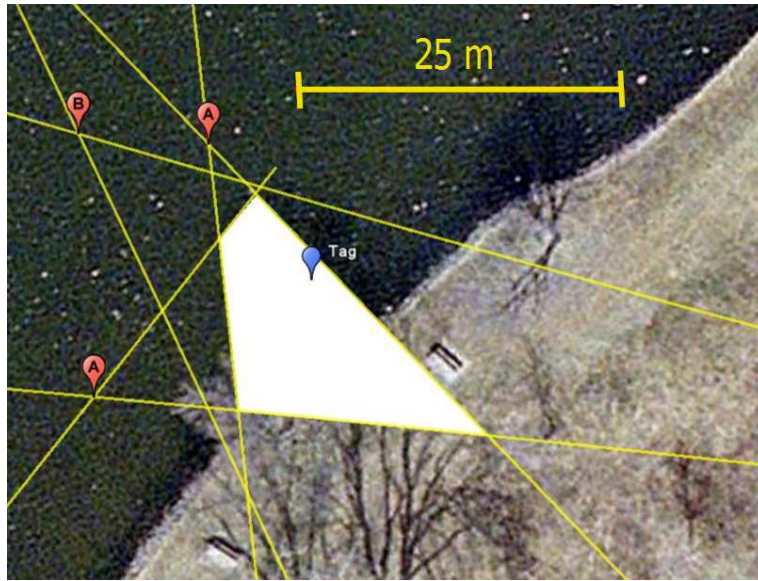

Figure 10: Triangulation experiment: The raft visited 3 pre-defined waypoints and measured the signal strength by panning the antenna in steps of 45° . Cones of 45° are drawn around direction of maximum signal strength at locations A , B and C . Their intersecting polygon represents the possible location of the tag. The tag was actually placed at the location marked “Tag”.

indicate the direction of maximum signal strength. Their intersection region corresponds to the possible location of the tag. The true location of the tag is marked in the figure by “Tag”. It must be noted that the readings at each point were obtained in steps of 45° and hence at each location we obtain a cone (extending from -22.5° to $+22.5^\circ$) rather than a single line. The intersection result in this scenario is a polygon, the interiors of which denotes the possible location of the tag. The intersecting polygon shown in Figure 10 has a total area of about $176m^2$. Note that this area can be further reduced by decreasing the step size from 45° to a smaller value. Also note that this area is a function of the locations A , B and C with respect to “Tag”.

The various field experiments clearly demonstrate that the raft is capable of navigating in a robust fashion and detecting the presence of fish reliably. The primary results in localizing the fish precisely are promising, and our future work is directed towards improving this capability further.

6 Conclusion

In this paper, we presented progress in building a robotic sensor network for monitoring carp in Minnesota lakes. Field experiments clearly demonstrate that a light-weight, inexpensive robotic system has the potential for tremendous utility in environmental monitoring by allowing scientists to collect data over long periods of time from hard-to-reach locations. Trials conducted in normal conditions show that the raft closely follows the reference trajectory (with a mean deviation of about 3 meters). In extreme conditions, when operating close to fast-moving water skiers the raft still manages to track the reference trajectory, although with higher deviation (about 12 meters). Preliminary experiments in fish localization using signal strength and bearing measurements are promising and suggest that better localization can be achieved.

We are working on improving our system in a number of directions. Here, we present a brief overview of our agenda.

Energy: Currently, the system has limited battery life of 5 hours of continuous operation. We are planning to add solar panels to improve the lifetime of the system. Environmental scientists frequently require collecting data in the night and daybreak. Hence, the system cannot completely rely on solar panels as power source and would require on-board battery. This opens up interesting algorithmic questions regarding energy harvesting during search and tracking and energy efficient operation.

Higher-level autonomy and obstacle avoidance: Currently, the system follows GPS waypoints predefined by the user, while searching for fish in the lake. In the next phase, we will focus on adaptive, autonomous behavior. We are currently working on high-level search strategies that maximize the probability of locating the fish. We are also working on designing strategies for tracking individual fish after locating it. To execute these strategies in dynamic environments, it is necessary to add obstacle detection and avoidance capabilities. We plan to start with camera-based techniques which have been successfully used in existing systems (Gong et al., 2008).

Localization accuracy: As described in the paper, signal strength and bearing information individually are insufficient for accurate localization of the fish. We are investigating ways for augmenting both the information in a unified manner for better localization.

Multi-raft systems: For localizing a fish with a single raft, two or more readings from different locations are needed. By the time the raft moves from one point to the other, the fish can move, and the resulting localization may not be precise. However, if there are two or more rafts working in coordination, the fish could

be localized at a single instance of time with one reading from each raft. This would give better localization. Multiple rafts could also prove useful in searching the lake for presence of fish and while tracking a single fish. The design of inexpensive, easy-to-build systems (such as the one presented here) is especially important for building real-life multi-robot systems.

Acknowledgments

The authors are grateful to Prof. Peter Sorensen and the members of his lab for numerous useful discussions and sharing equipment. This work is supported in part by NSF Projects 0917676, 0907658 and 0936710, and a fellowship from the Institute on the Environment at the University of Minnesota.

References

- Akkaya, K. and Younis, M. (2005). A survey on routing protocols for wireless sensor networks. *Ad Hoc Networks*, 3(3):325 – 349.
- Blidberg, D. (2001). The development of autonomous underwater vehicles (AUVs); a brief summary. In *IEEE ICRA*.
- Caccia, M., Bibuli, M., Bono, R., and Bruzzone, G. (2008). Basic navigation, guidance and control of an Unmanned Surface Vehicle. *Autonomous Robots*, 25(4):349–365.
- Dunbabin, M., Corke, P., Vasilescu, I., and Rus, D. (2009). Experiments with Cooperative Control of Underwater Robots. *The International Journal of Robotics Research*, 28(6):815.
- Dunbabin, M., Roberts, J., Usher, K., Winstanley, G., and Corke, P. (2005). A hybrid AUV design for shallow water reef navigation. In *Robotics and Automation, 2005. ICRA 2005. Proceedings of the 2005 IEEE International Conference on*, pages 2105–2110.
- Ferreira, H., Martins, A., Dias, A., Almeida, C., Almeida, J., and Silva, E. (2006). Roaz Autonomous Surface Vehicle Design and Implementation. *Proceedings of the ROBOTICA Conference, Portugal*.
- Gong, X., Xu, B., Reed, C., Wyatt, C., and Stilwell, D. (2008). Real-time robust mapping for an autonomous surface vehicle using an omnidirectional camera. *Applications of Computer Vision, IEEE Workshop on*, 0:1–6.
- Higinbotham, J., Moisan, J., Schirtzinger, C., Linkswiler, M., Yungel, J., and Orton, P. (2008). Update

- on the development and testing of a new long duration solar powered autonomous surface vehicle. In *OCEANS 2008*, pages 1–10.
- Kumagai, M., Ura, T., Kuroda, Y., and Walker, R. (2002). A new autonomous underwater vehicle designed for lake environment monitoring. *Advanced Robotics*, 16(1):17–26.
- Marani, G., Choi, S., and Yuh, J. (2009). Underwater autonomous manipulation for intervention missions AUVs. *Ocean Engineering*, 36(1):15–23.
- Network World (2009). Vineyard uses sensor network to fine-tune irrigation, <http://www.networkworld.com/newsletters/wireless/2009/030209wireless2.html>.
- Shroyer, S. and Logsdon, D. (2009). Detection Distances of Selected Radio and Acoustic Tags in Minnesota Lakes and Rivers. *North American Journal of Fisheries Management*, 29:876–884.
- Smith, R. N., Das, J., Heidarsson, H., Pereira, A. A., Arrichiello, F., Cetinic, I., Darjany, L., Garneau, M.-E., Howard, M. D., Oberg, C., Ragan, M., Seubert, E., Smith, E. C., Stauffer, B., Schnetzer, A., Toro-Farmer, G., Caron, D. A., Jones, B. H., and Sukhatme, G. S. (2010). Usc cinaps builds bridges: Observing and monitoring the southern california bight. *IEEE Robotics and Automation Magazine*, 17(1):20–30.
- Steimle, E. and Hall, M. (2006). Unmanned surface vehicles as environmental monitoring and assessment tools. In *OCEANS 2006*, pages 1–5.
- Subramanian, A., Gong, X., Riggins, J., Stilwell, D., and Wyatt, C. (2006). Shoreline mapping using an omni-directional camera for autonomous surface vehicle applications. In *OCEANS 2006*, pages 1–6.
- Sukhatme, G., Dhariwal, A., Zhang, B., Oberg, C., Stauffer, B., and Caron, D. (2007). Design and development of a wireless robotic networked aquatic microbial observing system. *Environmental Engineering Science*, 24(2):205–215.
- Vasilescu, I., Detweiler, C., Doniec, M., Gurdan, D., Sosnowski, S., Stumpf, J., and Rus, D. (2010). AMOUR V: A Hovering Energy Efficient Underwater Robot Capable of Dynamic Payloads. *The International Journal of Robotics Research*.
- Williams, S., Pizarro, O., How, M., Mercer, D., Powell, G., Marshall, J., and Hanlon, R. (2009). Surveying nocturnal cuttlefish camouflage behaviour using an auv. In *Robotics and Automation, 2009. ICRA '09. IEEE International Conference on*, pages 214–219.