

TRAINING CONVOLUTIONAL NEURAL NETWORK

HYUN SOO PARK

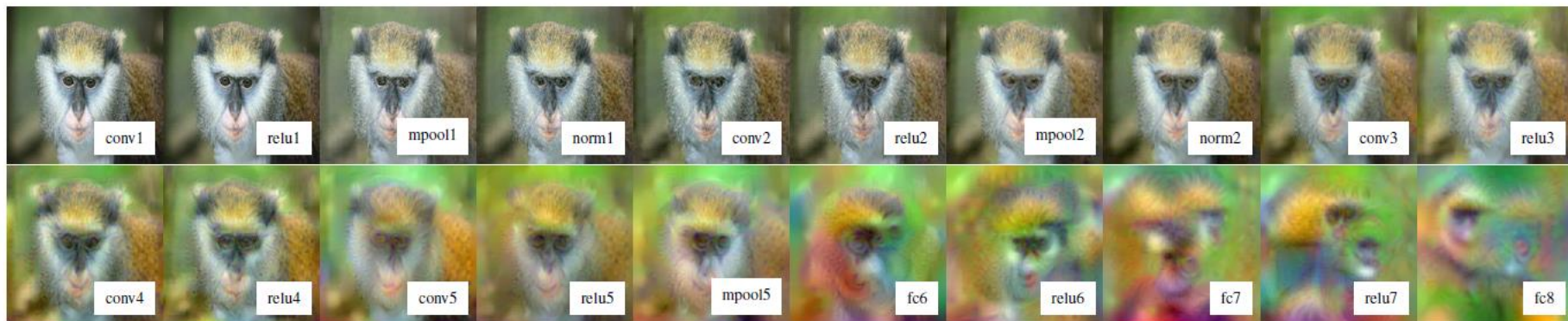

PREDICTION

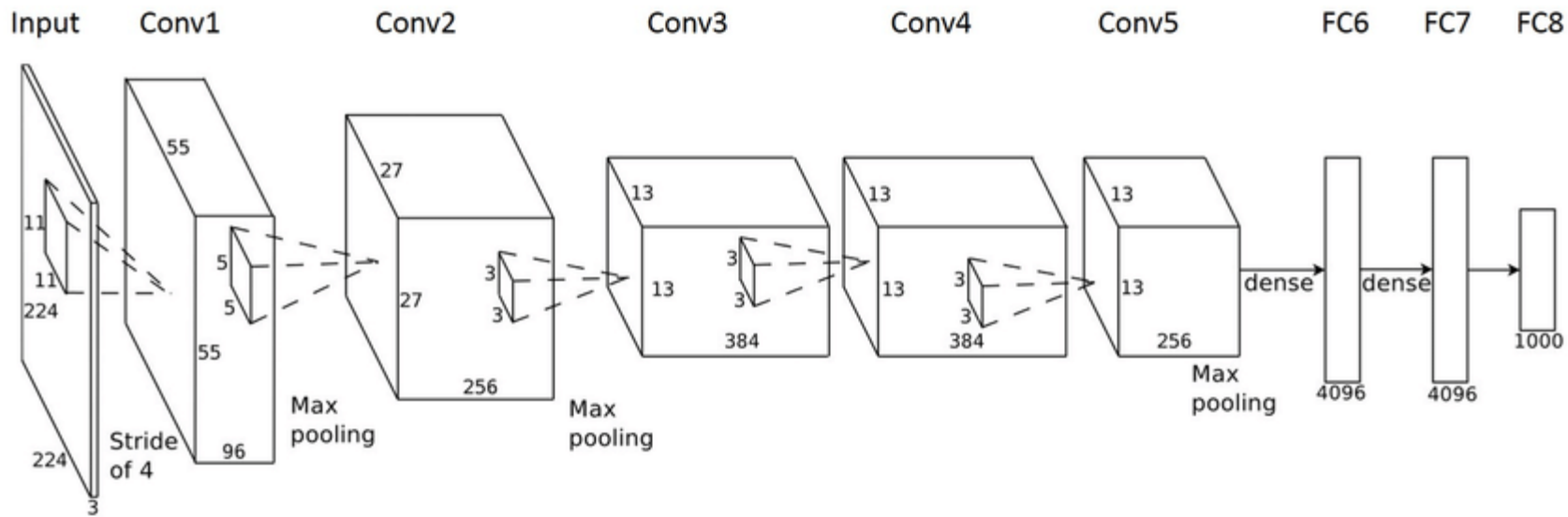
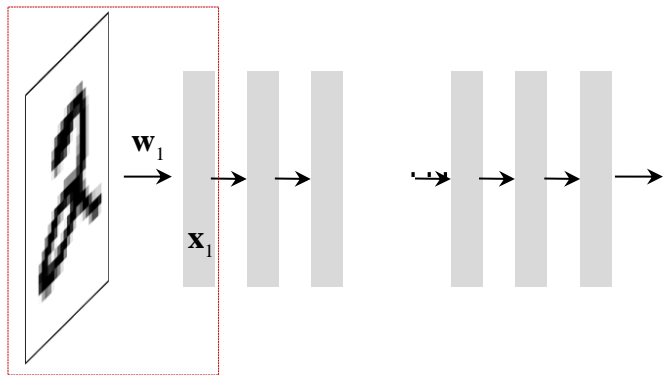

$$\mathbf{x}_1 = f(I; \mathbf{w}_1)$$

PREDICTION

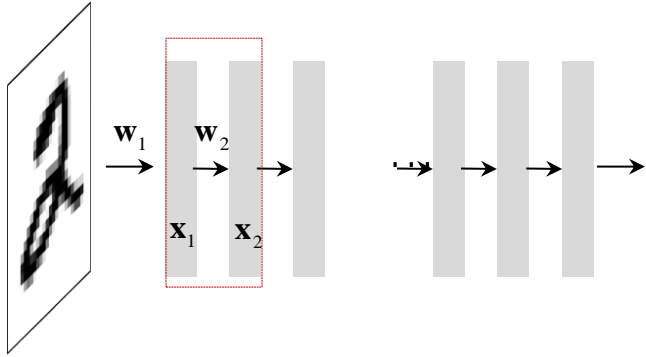

$$\mathbf{x}_1 = f(I; \mathbf{w}_1)$$

$$\mathbf{x}_2 = f(\mathbf{x}_1; \mathbf{w}_2)$$

PREDICTION

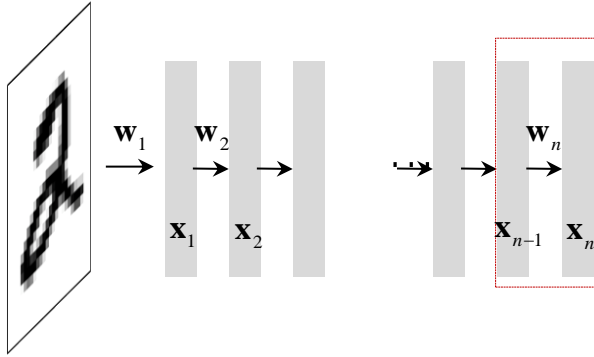

$$\mathbf{x}_1 = f(I; \mathbf{w}_1)$$

$$\mathbf{x}_2 = f(\mathbf{x}_1; \mathbf{w}_2)$$

$$\mathbf{x} = f(\mathbf{x}_{n-1}; \mathbf{w}_n)$$

PREDICTION

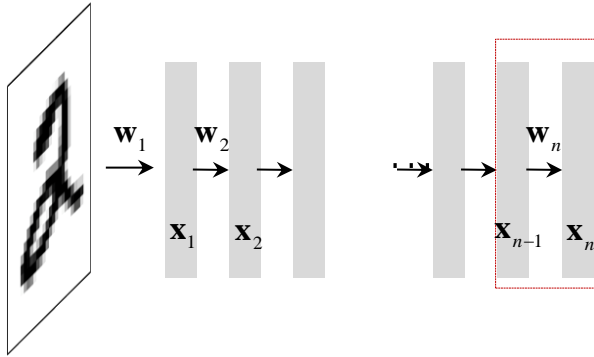

function $y = \text{foo}(x)$

$$\mathbf{x}_1 = f(I; \mathbf{w}_1)$$

$$\mathbf{x}_2 = f(\mathbf{x}_1; \mathbf{w}_2)$$

$$\mathbf{x} = f(\mathbf{x}_{n-1}; \mathbf{w}_n)$$

RECALL: BACK-PROPAGATION ALGORITHM W/ STOCHASTIC GRADIENT DESCENT

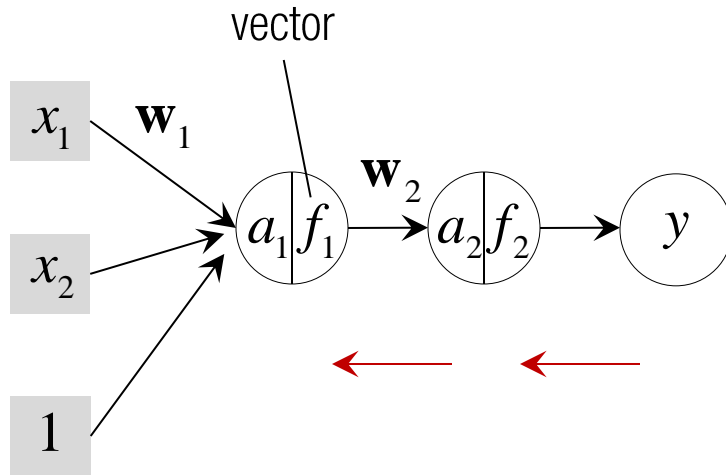

$$f_2 = \sigma(\mathbf{w}_2 \cdot \sigma(\mathbf{w}_1 \cdot \mathbf{x}))$$

While until converges:

Sample mini-batch

For each data sample in mini-batch,

1. Prediction

$$f_2 = \sigma(\mathbf{w}_2 \cdot \sigma(\mathbf{w}_1 \cdot \mathbf{x}))$$

2. Measure error

$$L(\mathbf{w}_1, \mathbf{w}_2) = \sum_i (\tilde{y}^i - y^i)^2$$

3. Back-propagation

$$\frac{\partial L}{\partial \mathbf{w}_2} = \frac{\partial L}{\partial f_2} \frac{\partial f_2}{\partial a_2} \frac{\partial a_2}{\partial \mathbf{w}_2} \quad \frac{\partial L}{\partial \mathbf{w}_1} = \frac{\partial L}{\partial f_2} \frac{\partial f_2}{\partial a_2} \frac{\partial a_2}{\partial f_1} \frac{\partial f_1}{\partial a_1} \frac{\partial a_1}{\partial \mathbf{w}_1}$$

Update gradient

$$\mathbf{w}_1 = \mathbf{w}_1 - \gamma \frac{\partial L}{\partial \mathbf{w}_1} \quad \mathbf{w}_2 = \mathbf{w}_2 - \gamma \frac{\partial L}{\partial \mathbf{w}_2}$$

RECALL: BACK-PROPAGATION

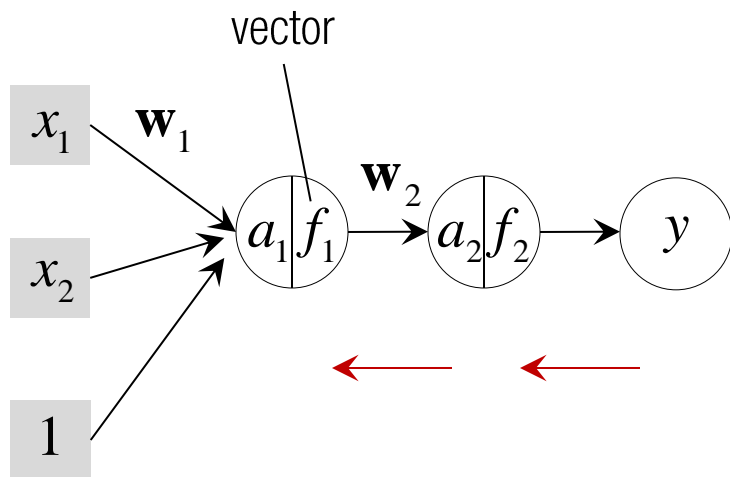

$$f_2 = \sigma(\mathbf{w}_2 \cdot \sigma(\mathbf{w}_1 \cdot \mathbf{x}))$$

$$L(\mathbf{w}_1, \mathbf{w}_2) = \sum_i (\tilde{y}^i - y^i)^2$$

Weight update rule:

$$\mathbf{w} = \mathbf{w} - \gamma \frac{\partial L}{\partial \mathbf{w}}$$

$$\frac{\partial L}{\partial \mathbf{w}_2} = \frac{\partial L}{\partial f_2} \frac{\partial f_2}{\partial a_2} \frac{\partial a_2}{\partial \mathbf{w}_2}$$

$$\frac{\partial L}{\partial \mathbf{w}_1} = \frac{\partial L}{\partial f_2} \frac{\partial f_2}{\partial a_2} \frac{\partial a_2}{\partial f_1} \frac{\partial f_1}{\partial a_1} \frac{\partial a_1}{\partial \mathbf{w}_1}$$

BACK-PROPAGATION

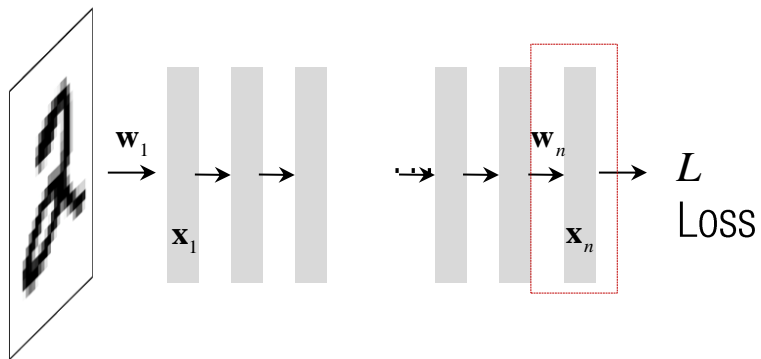

$$\frac{\partial L}{\partial \mathbf{w}_n} = \frac{\partial L}{\partial \mathbf{x}_n} \frac{\partial \mathbf{x}_n}{\partial \mathbf{w}_n}$$

$$\mathbf{w}_n = \mathbf{w}_n - \gamma \frac{\partial L}{\partial \mathbf{w}_n}$$

BACK-PROPAGATION

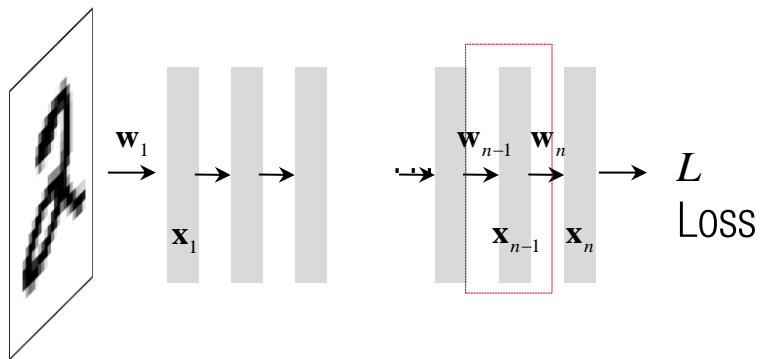

$$\frac{\partial L}{\partial \mathbf{w}_n} = \frac{\partial L}{\partial \mathbf{x}_n} \frac{\partial \mathbf{x}_n}{\partial \mathbf{w}_n}$$

$$\begin{aligned} \frac{\partial L}{\partial \mathbf{w}_{n-1}} &= \frac{\partial L}{\partial \mathbf{x}_n} \frac{\partial \mathbf{x}_n}{\partial \mathbf{x}_{n-1}} \frac{\partial \mathbf{x}_{n-1}}{\partial \mathbf{w}_{n-1}} \\ &= \frac{\partial L}{\partial \mathbf{x}_{n-1}} \frac{\partial \mathbf{x}_{n-1}}{\partial \mathbf{w}_{n-1}} \end{aligned}$$

$$\mathbf{w}_n = \mathbf{w}_n - \gamma \frac{\partial L}{\partial \mathbf{w}_n}$$

$$\mathbf{w}_{n-1} = \mathbf{w}_{n-1} - \gamma \frac{\partial L}{\partial \mathbf{w}_{n-1}}$$

BACK-PROPAGATION

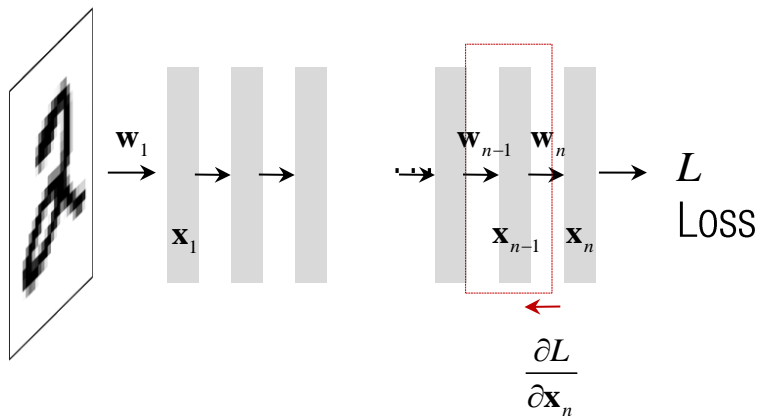

$$\frac{\partial L}{\partial w_n} = \frac{\partial L}{\partial x_n} \frac{\partial x_n}{\partial w_n}$$

$$\begin{aligned} \frac{\partial L}{\partial w_{n-1}} &= \frac{\partial L}{\partial x_n} \frac{\partial x_n}{\partial x_{n-1}} \frac{\partial x_{n-1}}{\partial w_{n-1}} \\ &= \frac{\partial L}{\partial x_{n-1}} \frac{\partial x_{n-1}}{\partial w_{n-1}} \end{aligned}$$

$$w_n = w_n - \gamma \frac{\partial L}{\partial w_n}$$

$$w_{n-1} = w_{n-1} - \gamma \frac{\partial L}{\partial w_{n-1}}$$

BACK-PROPAGATION

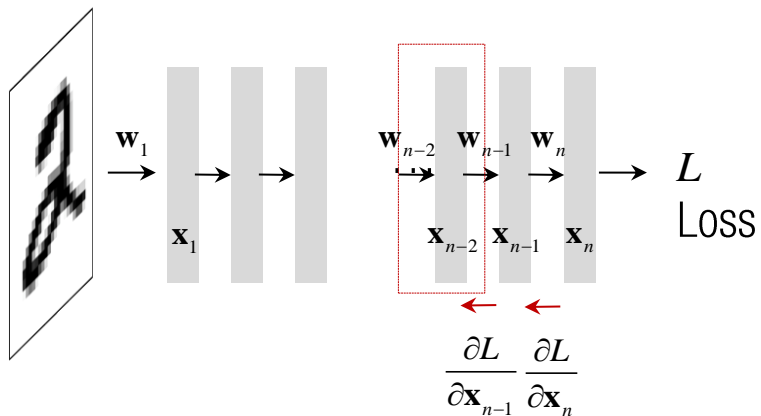

$$\frac{\partial L}{\partial \mathbf{w}_n} = \frac{\partial L}{\partial \mathbf{x}_n} \frac{\partial \mathbf{x}_n}{\partial \mathbf{w}_n}$$

$$\mathbf{w}_n = \mathbf{w}_n - \gamma \frac{\partial L}{\partial \mathbf{w}_n}$$

$$\frac{\partial L}{\partial \mathbf{w}_{n-1}} = \frac{\partial L}{\partial \mathbf{x}_n} \frac{\partial \mathbf{x}_n}{\partial \mathbf{x}_{n-1}} \frac{\partial \mathbf{x}_{n-1}}{\partial \mathbf{w}_{n-1}}$$

$$\mathbf{w}_{n-1} = \mathbf{w}_{n-1} - \gamma \frac{\partial L}{\partial \mathbf{w}_{n-1}}$$

$$= \frac{\partial L}{\partial \mathbf{x}_{n-1}} \frac{\partial \mathbf{x}_{n-1}}{\partial \mathbf{w}_{n-1}}$$

$$\frac{\partial L}{\partial \mathbf{w}_{n-2}} = \frac{\partial L}{\partial \mathbf{x}_n} \frac{\partial \mathbf{x}_n}{\partial \mathbf{x}_{n-1}} \frac{\partial \mathbf{x}_{n-1}}{\partial \mathbf{x}_{n-2}} \frac{\partial \mathbf{x}_{n-2}}{\partial \mathbf{w}_{n-2}}$$

$$\mathbf{w}_{n-2} = \mathbf{w}_{n-2} - \gamma \frac{\partial L}{\partial \mathbf{w}_{n-2}}$$

$$= \frac{\partial L}{\partial \mathbf{x}_{n-2}} \frac{\partial \mathbf{x}_{n-2}}{\partial \mathbf{w}_{n-2}}$$

BACK-PROPAGATION

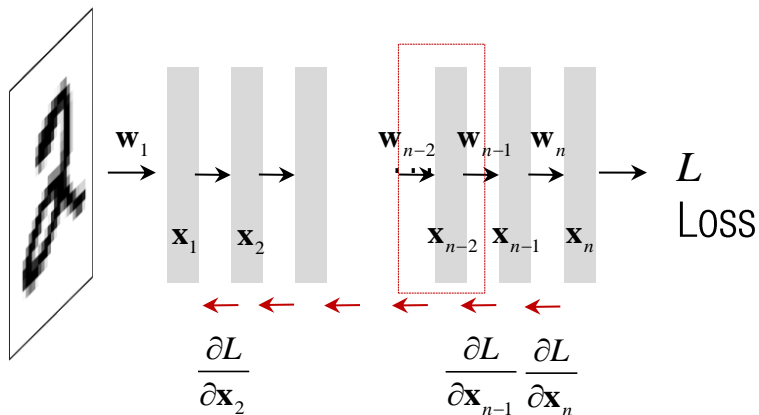

$$\frac{\partial L}{\partial \mathbf{w}_n} = \frac{\partial L}{\partial \mathbf{x}_n} \frac{\partial \mathbf{x}_n}{\partial \mathbf{w}_n}$$

$$\mathbf{w}_n = \mathbf{w}_n - \gamma \frac{\partial L}{\partial \mathbf{w}_n}$$

$$\frac{\partial L}{\partial \mathbf{w}_{n-1}} = \frac{\partial L}{\partial \mathbf{x}_n} \frac{\partial \mathbf{x}_n}{\partial \mathbf{x}_{n-1}} \frac{\partial \mathbf{x}_{n-1}}{\partial \mathbf{w}_{n-1}}$$

$$\mathbf{w}_{n-1} = \mathbf{w}_{n-1} - \gamma \frac{\partial L}{\partial \mathbf{w}_{n-1}}$$

$$= \frac{\partial L}{\partial \mathbf{x}_{n-1}} \frac{\partial \mathbf{x}_{n-1}}{\partial \mathbf{w}_{n-1}}$$

$$\frac{\partial L}{\partial \mathbf{w}_{n-2}} = \frac{\partial L}{\partial \mathbf{x}_n} \frac{\partial \mathbf{x}_n}{\partial \mathbf{x}_{n-1}} \frac{\partial \mathbf{x}_{n-1}}{\partial \mathbf{x}_{n-2}} \frac{\partial \mathbf{x}_{n-2}}{\partial \mathbf{w}_{n-2}}$$

$$\mathbf{w}_{n-2} = \mathbf{w}_{n-2} - \gamma \frac{\partial L}{\partial \mathbf{w}_{n-2}}$$

$$= \frac{\partial L}{\partial \mathbf{x}_{n-2}} \frac{\partial \mathbf{x}_{n-2}}{\partial \mathbf{w}_{n-2}}$$

$$\frac{\partial L}{\partial \mathbf{w}_1} = \frac{\partial L}{\partial \mathbf{x}_n} \frac{\partial \mathbf{x}_n}{\partial \mathbf{x}_{n-1}} \dots \frac{\partial \mathbf{x}_2}{\partial \mathbf{x}_1} \frac{\partial \mathbf{x}_1}{\partial \mathbf{w}_1}$$

$$\mathbf{w}_1 = \mathbf{w}_1 - \gamma \frac{\partial L}{\partial \mathbf{w}_1}$$

$$= \frac{\partial L}{\partial \mathbf{x}_1} \frac{\partial \mathbf{x}_1}{\partial \mathbf{w}_1}$$

BACK-PROPAGATION

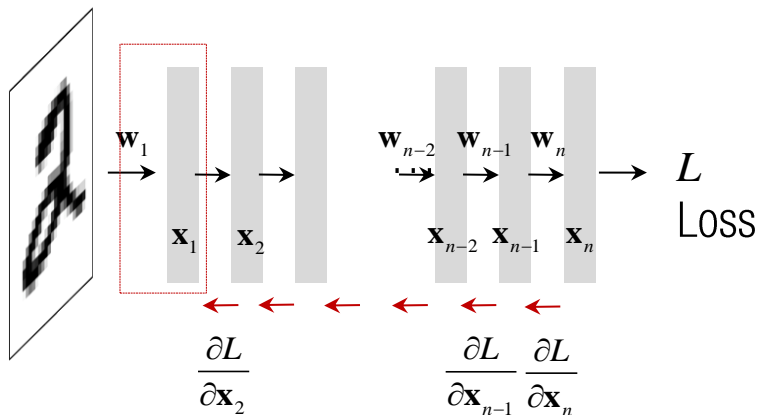

function $y = \text{foo}(x)$

function $[\text{dLdx} \ \text{dLdw} \ \text{dLdb}] = \text{foo_back}(\text{dLdy}, x, y)$

Weight update

Loss propagation

$$\frac{\partial L}{\partial \mathbf{w}_n} = \frac{\partial L}{\partial \mathbf{x}_n} \frac{\partial \mathbf{x}_n}{\partial \mathbf{w}_n}$$

$$\mathbf{w}_n = \mathbf{w}_n - \gamma \frac{\partial L}{\partial \mathbf{w}_n}$$

$$\frac{\partial L}{\partial \mathbf{w}_{n-1}} = \frac{\partial L}{\partial \mathbf{x}_n} \frac{\partial \mathbf{x}_n}{\partial \mathbf{x}_{n-1}} \frac{\partial \mathbf{x}_{n-1}}{\partial \mathbf{w}_{n-1}}$$

$$\mathbf{w}_{n-1} = \mathbf{w}_{n-1} - \gamma \frac{\partial L}{\partial \mathbf{w}_{n-1}}$$

$$= \frac{\partial L}{\partial \mathbf{x}_{n-1}} \frac{\partial \mathbf{x}_{n-1}}{\partial \mathbf{w}_{n-1}}$$

$$\frac{\partial L}{\partial \mathbf{w}_{n-2}} = \frac{\partial L}{\partial \mathbf{x}_n} \frac{\partial \mathbf{x}_n}{\partial \mathbf{x}_{n-1}} \frac{\partial \mathbf{x}_{n-1}}{\partial \mathbf{x}_{n-2}} \frac{\partial \mathbf{x}_{n-2}}{\partial \mathbf{w}_{n-2}}$$

$$\mathbf{w}_{n-2} = \mathbf{w}_{n-2} - \gamma \frac{\partial L}{\partial \mathbf{w}_{n-2}}$$

$$= \frac{\partial L}{\partial \mathbf{x}_{n-2}} \frac{\partial \mathbf{x}_{n-2}}{\partial \mathbf{w}_{n-2}}$$

$$\frac{\partial L}{\partial \mathbf{w}_1} = \frac{\partial L}{\partial \mathbf{x}_n} \frac{\partial \mathbf{x}_n}{\partial \mathbf{x}_{n-1}} \dots \frac{\partial \mathbf{x}_2}{\partial \mathbf{x}_1} \frac{\partial \mathbf{x}_1}{\partial \mathbf{w}_1}$$

$$\mathbf{w}_1 = \mathbf{w}_1 - \gamma \frac{\partial L}{\partial \mathbf{w}_1}$$

$$= \frac{\partial L}{\partial \mathbf{x}_1} \frac{\partial \mathbf{x}_1}{\partial \mathbf{w}_1}$$

LOSS BACK-PROPAGATION

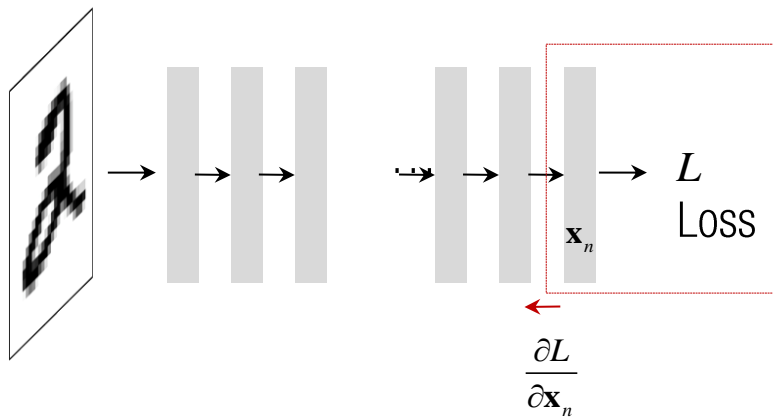

$$\frac{\partial L}{\partial x_n}$$

RECALL: ERROR MEASURE (LOSS)

$$\mathbf{x} \in \mathbb{R}^L$$

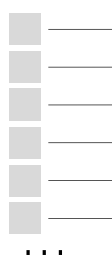

max
Soft

$$\tilde{\mathbf{y}} \in [0,1]^L$$

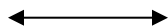

$$\tilde{\mathbf{y}} \in \{0,1\}^L$$



L : # of class labels

Cross-entropy loss (matching prob. distribution)

$$L = \sum_i \mathbf{y}_i \log \tilde{\mathbf{y}}_i \quad \text{where } \tilde{\mathbf{y}}_i = \frac{e^{x_i}}{\sum_i e^{x_i}} \quad \text{soft-max}$$

Prediction

Ground truth

ENTROPY LOSS DERIVATIVE

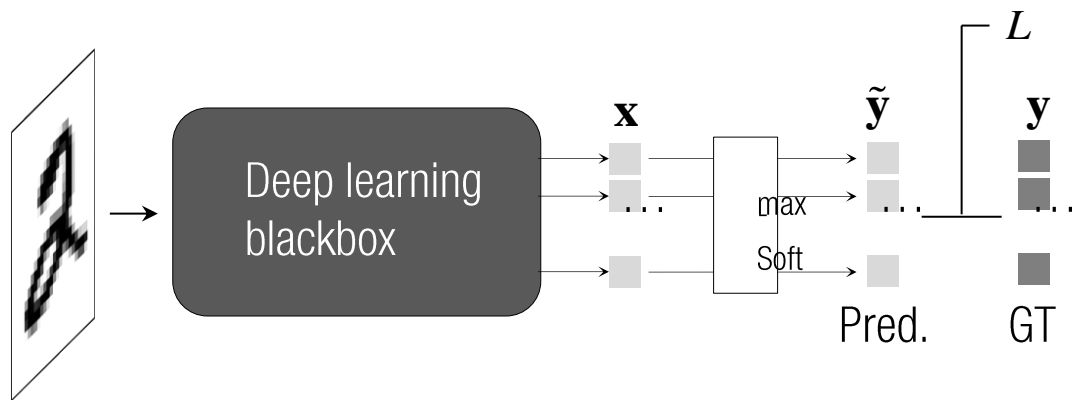

ENTROPY LOSS DERIVATIVE

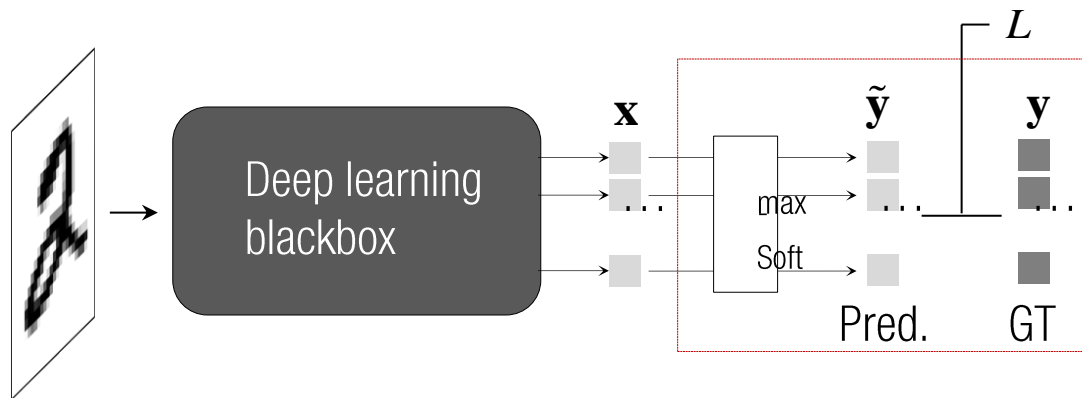

Input:

Trainable var.:

Output:

ENTROPY LOSS DERIVATIVE

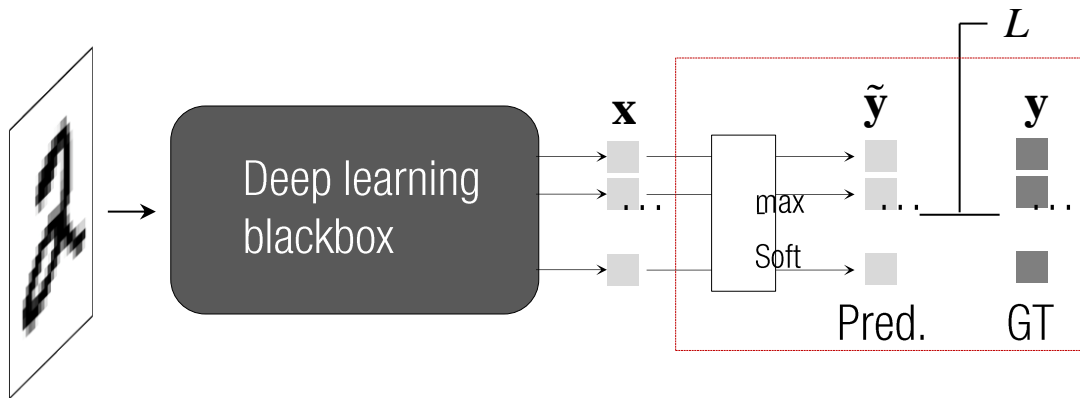

Input: \mathbf{x}

Trainable var.: None

Output: $L = \sum_i \mathbf{y}_i \log \tilde{\mathbf{y}}_i$ where $\tilde{\mathbf{y}}_i = \frac{e^{x_i}}{\sum_i e^{x_i}}$

ENTROPY LOSS DERIVATIVE

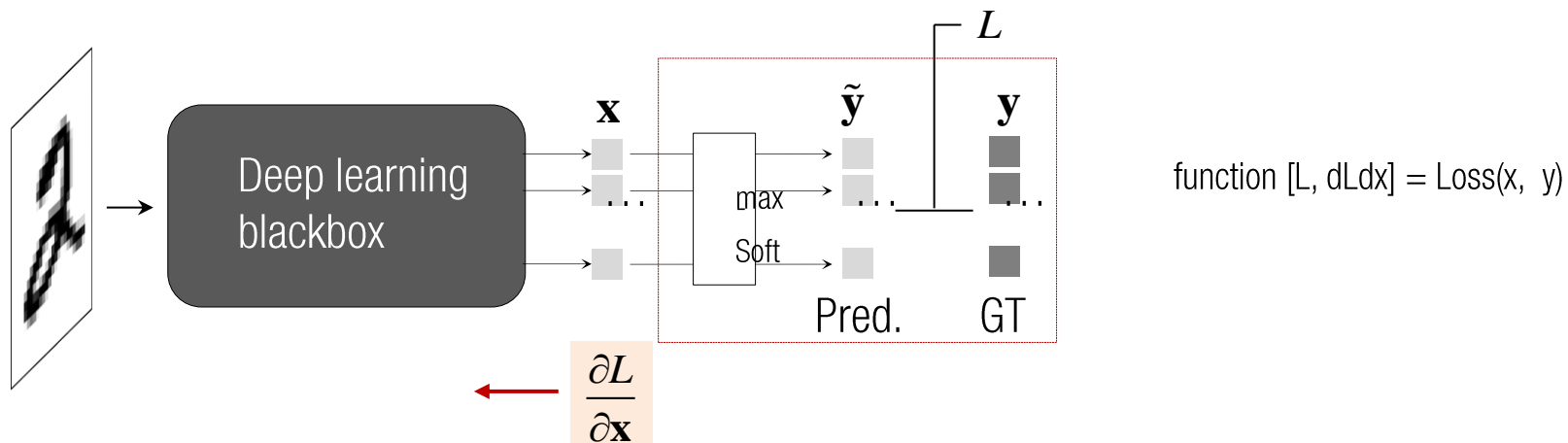

Input: \mathbf{x}	$\frac{\partial L}{\partial \mathbf{x}_i} = \tilde{\mathbf{y}}_i - \mathbf{y}_i$ 1 x n
Trainable var.: None	None
Output: $L = \sum_i \mathbf{y}_i \log \tilde{\mathbf{y}}_i$ where $\tilde{\mathbf{y}}_i = \frac{e^{\mathbf{x}_i}}{\sum_i e^{\mathbf{x}_i}}$	

RECALL: FC+ReLU

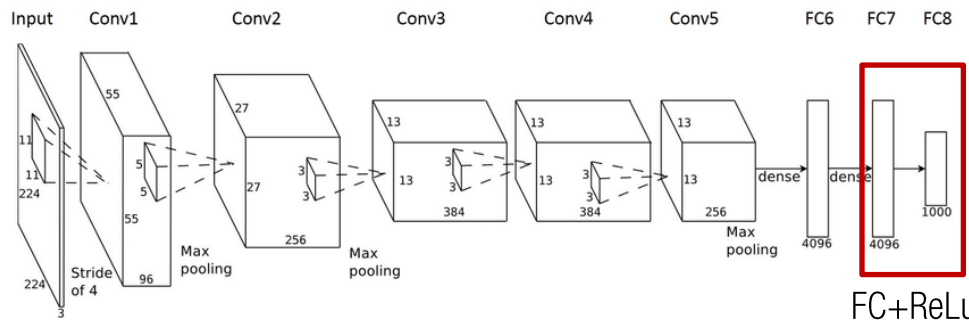
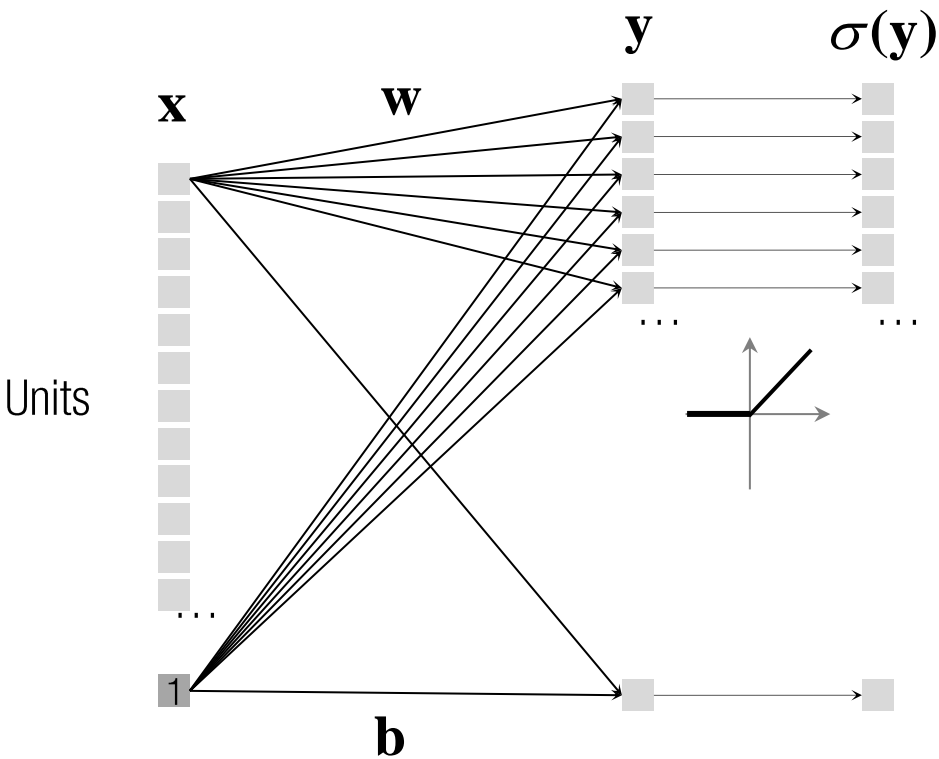

FULLY CONNECTED LAYER

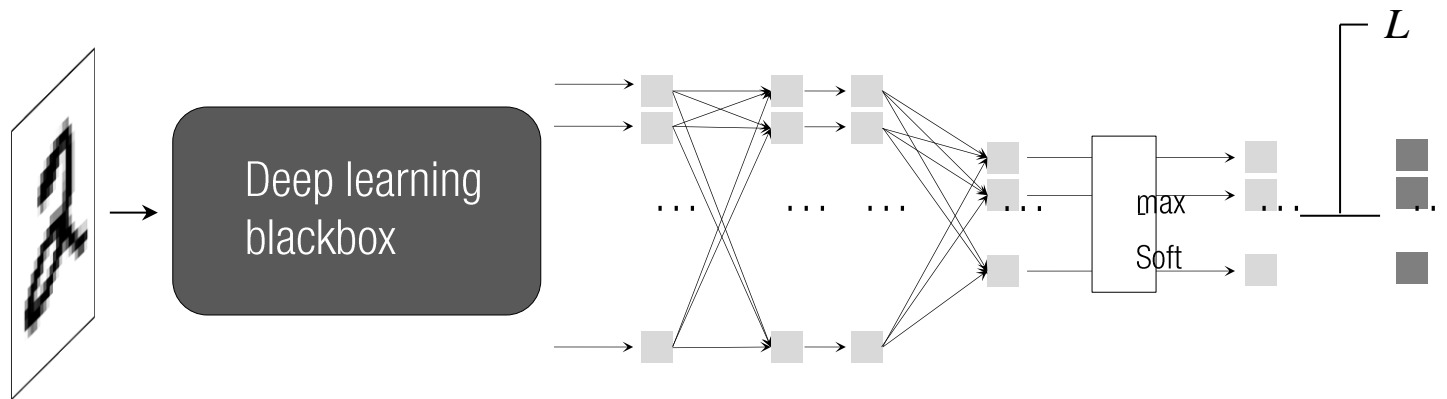

FULLY CONNECTED LAYER

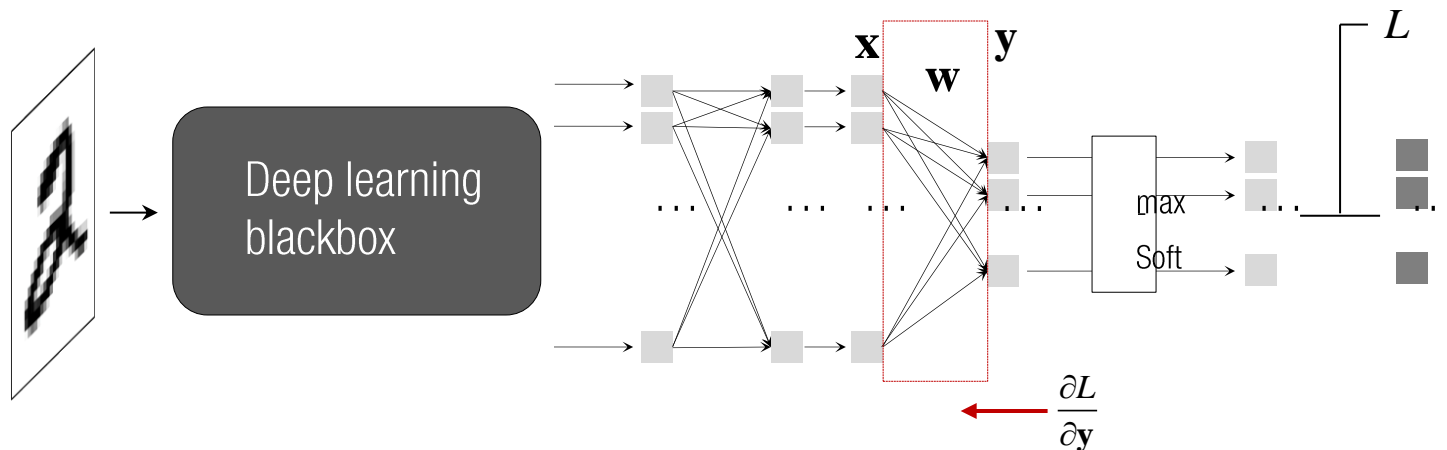

Input: $\mathbf{x} \in \mathbb{R}^n$

Trainable var.: $\mathbf{w} \in \mathbb{R}^{m \times n}$

Output: $\mathbf{y} = \mathbf{w}\mathbf{x}$
 $\mathbf{y} \in \mathbb{R}^m$

$$\frac{\partial \mathbf{y}}{\partial \mathbf{x}} = \begin{bmatrix} \frac{\partial y_1}{\partial x_1} & \dots & \frac{\partial y_1}{\partial x_n} \\ \vdots & \ddots & \vdots \\ \frac{\partial y_m}{\partial x_1} & \dots & \frac{\partial y_m}{\partial x_n} \end{bmatrix} = \mathbf{w} \rightarrow \frac{\partial L}{\partial \mathbf{x}} = \frac{\partial L}{\partial \mathbf{y}} \mathbf{w}$$

FULLY CONNECTED LAYER

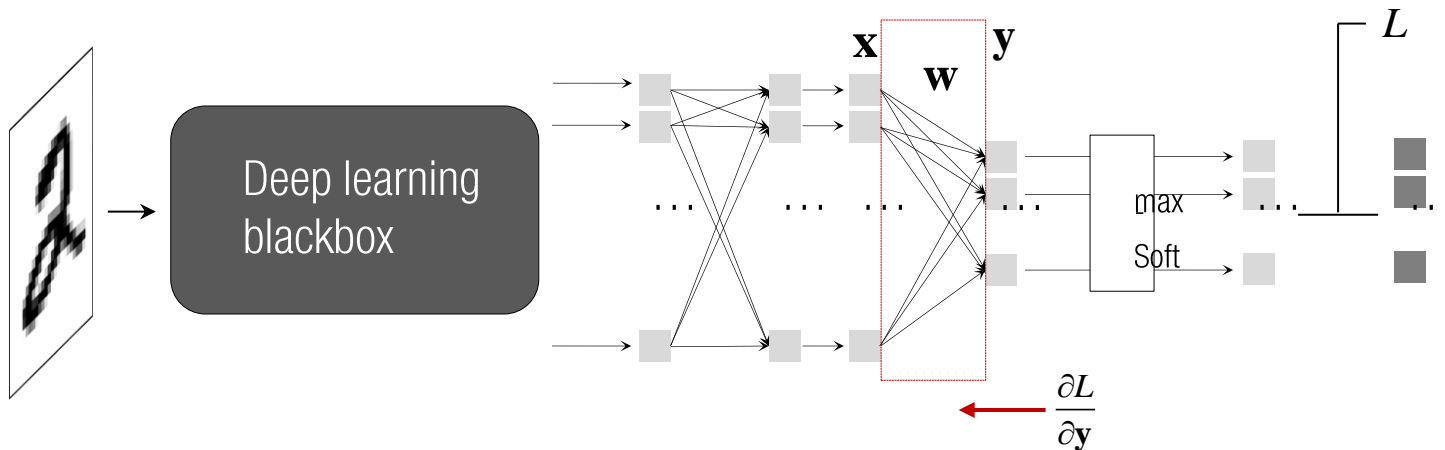

Input: $\mathbf{x} \in \mathbb{R}^n$

Trainable var.: $\mathbf{w} \in \mathbb{R}^{m \times n}$

Output: $\mathbf{y} = \mathbf{w}\mathbf{x}$
 $\mathbf{y} \in \mathbb{R}^m$

$$\frac{\partial \mathbf{y}}{\partial \mathbf{x}} = \begin{bmatrix} \frac{\partial y_1}{\partial x_1} & \dots & \frac{\partial y_1}{\partial x_n} \\ \vdots & \ddots & \vdots \\ \frac{\partial y_m}{\partial x_1} & \dots & \frac{\partial y_m}{\partial x_n} \end{bmatrix} = \mathbf{w} \rightarrow \frac{\partial L}{\partial \mathbf{x}} = \frac{\partial L}{\partial \mathbf{y}} \mathbf{w}$$

1xn

FULLY CONNECTED LAYER

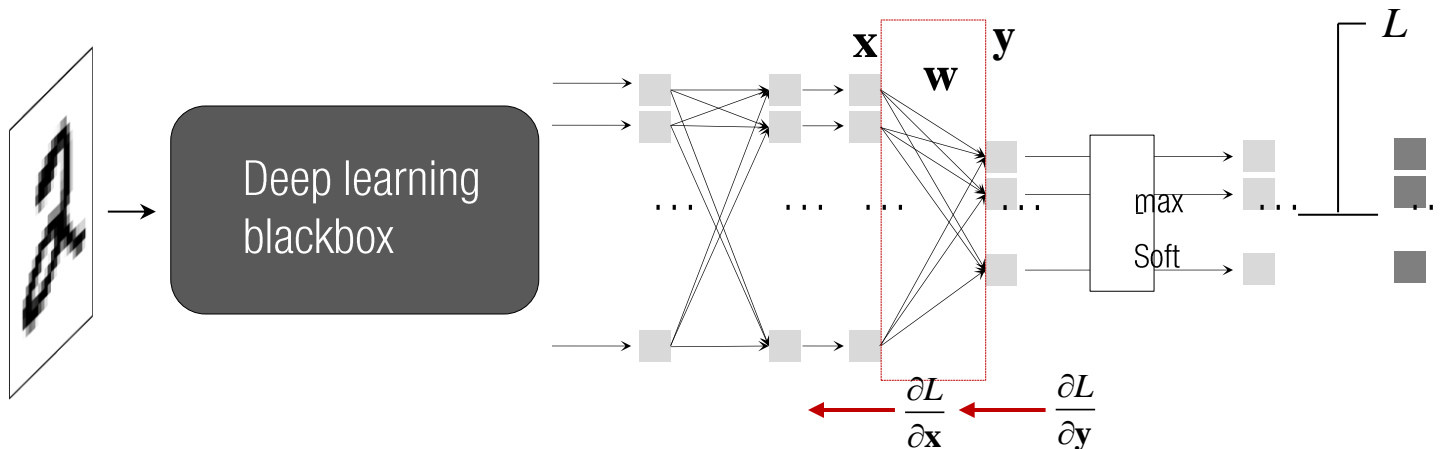

Input: $\mathbf{x} \in \mathbb{R}^n$

$$\frac{\partial L}{\partial \mathbf{x}_i} = \sum_j \frac{\partial L}{\partial \mathbf{y}_j} \frac{\partial \mathbf{y}_j}{\partial \mathbf{x}_i} = \quad 1 \times n$$

Trainable var.: $\mathbf{w} \in \mathbb{R}^{m \times n}$

Output: $\mathbf{y} = \mathbf{w}\mathbf{x}$
 $\mathbf{y} \in \mathbb{R}^m$

FULLY CONNECTED LAYER

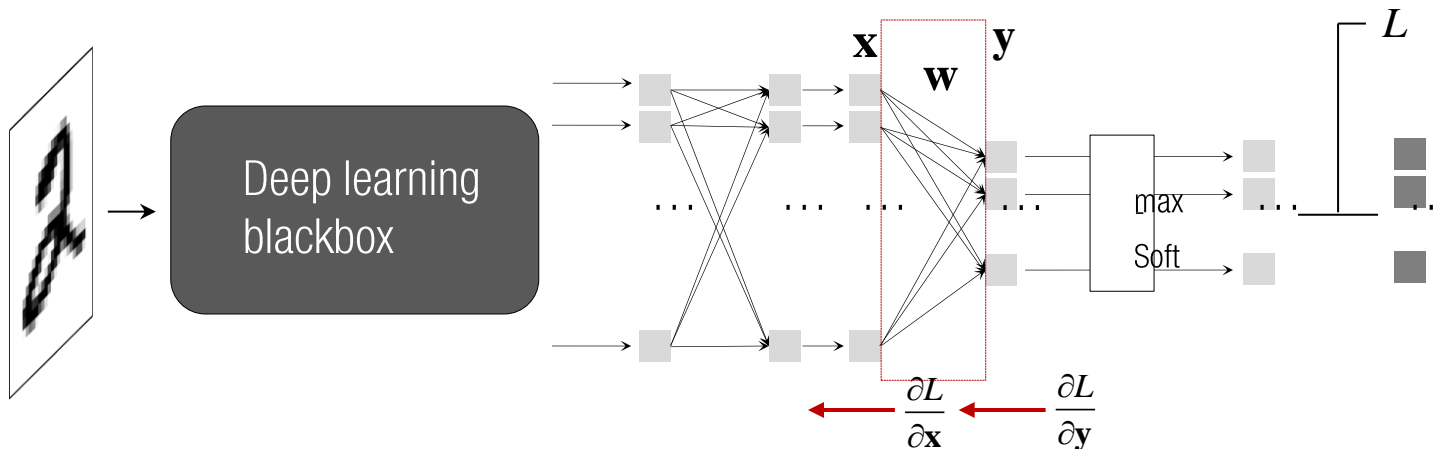

Input: $\mathbf{x} \in \mathbb{R}^n$

$$\frac{\partial L}{\partial \mathbf{x}_i} = \sum_j \frac{\partial L}{\partial \mathbf{y}_j} \frac{\partial \mathbf{y}_j}{\partial \mathbf{x}_i} = \sum_j \frac{\partial L}{\partial \mathbf{y}_j} \mathbf{w}_{ji} \quad 1 \times n$$

Trainable var.: $\mathbf{w} \in \mathbb{R}^{m \times n}$

Output: $\mathbf{y} = \mathbf{w}\mathbf{x}$
 $\mathbf{y} \in \mathbb{R}^m$

FULLY CONNECTED LAYER

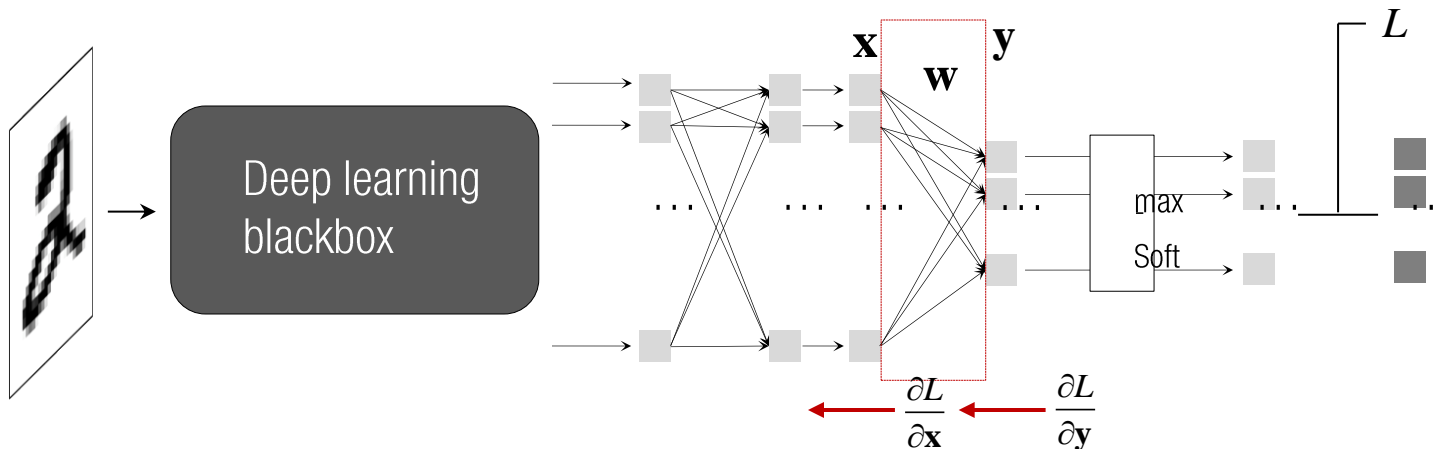

Input: $\mathbf{x} \in \mathbb{R}^n$

Trainable var.: $\mathbf{w} \in \mathbb{R}^{m \times n}$

Output: $\mathbf{y} = \mathbf{w}\mathbf{x}$
 $\mathbf{y} \in \mathbb{R}^m$

$$\frac{\partial L}{\partial \mathbf{x}_i} = \sum_j \frac{\partial L}{\partial \mathbf{y}_j} \frac{\partial \mathbf{y}_j}{\partial \mathbf{x}_i} = \sum_j \frac{\partial L}{\partial \mathbf{y}_j} \mathbf{w}_{ji} \quad 1 \times n$$

$$\frac{\partial L}{\partial \mathbf{w}_{ij}} = \sum_i \frac{\partial L}{\partial \mathbf{y}_i} \frac{\partial \mathbf{y}_i}{\partial \mathbf{w}_{ij}} \quad \mathbf{y}_i = \mathbf{w}_{i1}\mathbf{x}_1 + \dots + \mathbf{w}_{im}\mathbf{x}_m$$

FULLY CONNECTED LAYER

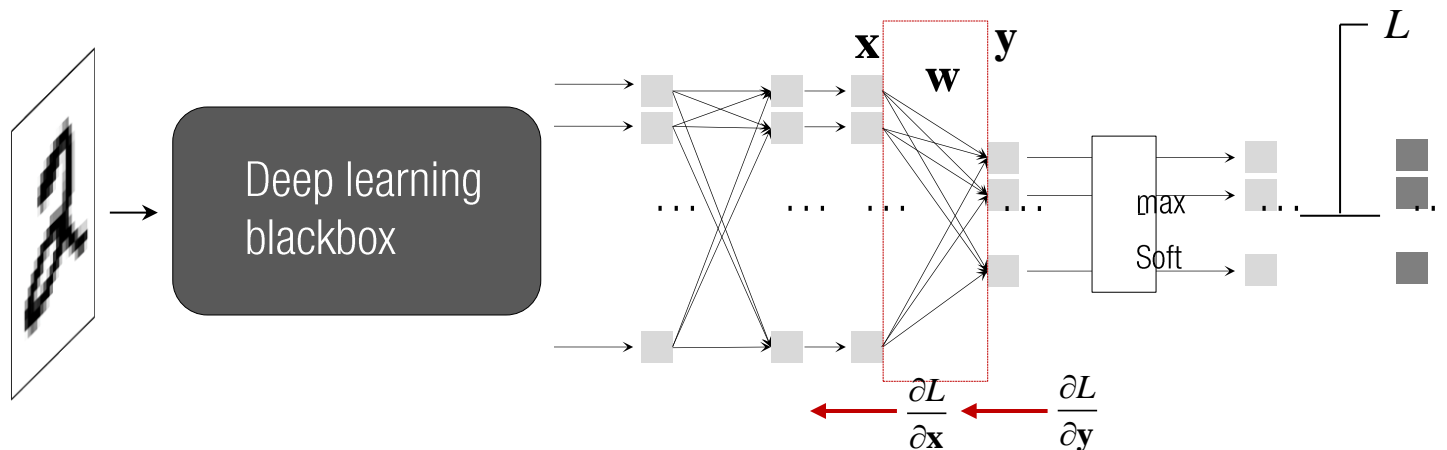

Input: $\mathbf{x} \in \mathbb{R}^n$

Trainable var.: $\mathbf{w} \in \mathbb{R}^{m \times n}$

Output: $\mathbf{y} = \mathbf{w}\mathbf{x}$
 $\mathbf{y} \in \mathbb{R}^m$

$$\frac{\partial L}{\partial \mathbf{x}_i} = \sum_j \frac{\partial L}{\partial \mathbf{y}_j} \frac{\partial \mathbf{y}_j}{\partial \mathbf{x}_i} = \sum_j \frac{\partial L}{\partial \mathbf{y}_j} \mathbf{w}_{ji} \quad 1 \times n$$

$$\frac{\partial L}{\partial \mathbf{w}_{ij}} = \sum_i \frac{\partial L}{\partial \mathbf{y}_i} \frac{\partial \mathbf{y}_i}{\partial \mathbf{w}_{ij}} = \frac{\partial L}{\partial \mathbf{y}_i} \mathbf{x}_j \quad 1 \times (n \times m)$$

FULLY CONNECTED LAYER

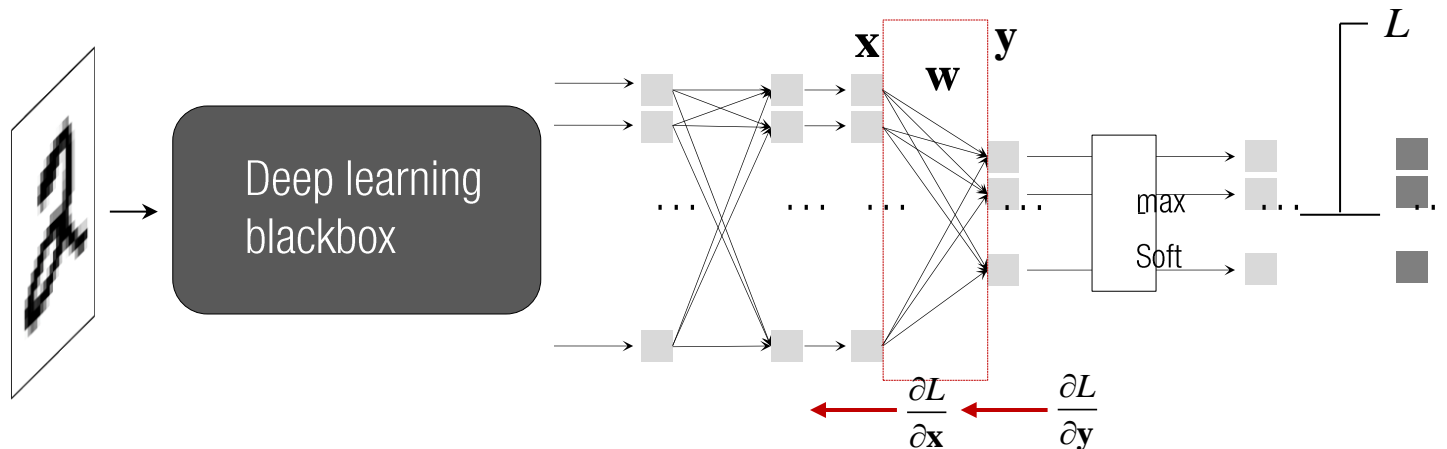

Input: $\mathbf{x} \in \mathbb{R}^n$

Trainable var.: $\mathbf{w} \in \mathbb{R}^{m \times n}$

Output: $\mathbf{y} = \mathbf{w}\mathbf{x}$
 $\mathbf{y} \in \mathbb{R}^m$

$$\frac{\partial L}{\partial \mathbf{x}_i} = \sum_j \frac{\partial L}{\partial \mathbf{y}_j} \frac{\partial \mathbf{y}_j}{\partial \mathbf{x}_i} = \sum_j \frac{\partial L}{\partial \mathbf{y}_j} \mathbf{w}_{ji} \quad 1 \times n$$

$$\frac{\partial L}{\partial \mathbf{w}_{ij}} = \sum_i \frac{\partial L}{\partial \mathbf{y}_i} \frac{\partial \mathbf{y}_i}{\partial \mathbf{w}_{ij}} = \frac{\partial L}{\partial \mathbf{y}_i} \mathbf{x}_j \quad 1 \times (n \times m)$$

function $[\mathbf{y}] = \text{FC}(\mathbf{x}, \mathbf{w})$

function $[\text{dLdx}, \text{dLdw}, \text{dLdb}] = \text{FC_back}(\text{dLdy}, \mathbf{x}, \mathbf{w}, \mathbf{y})$

RELU

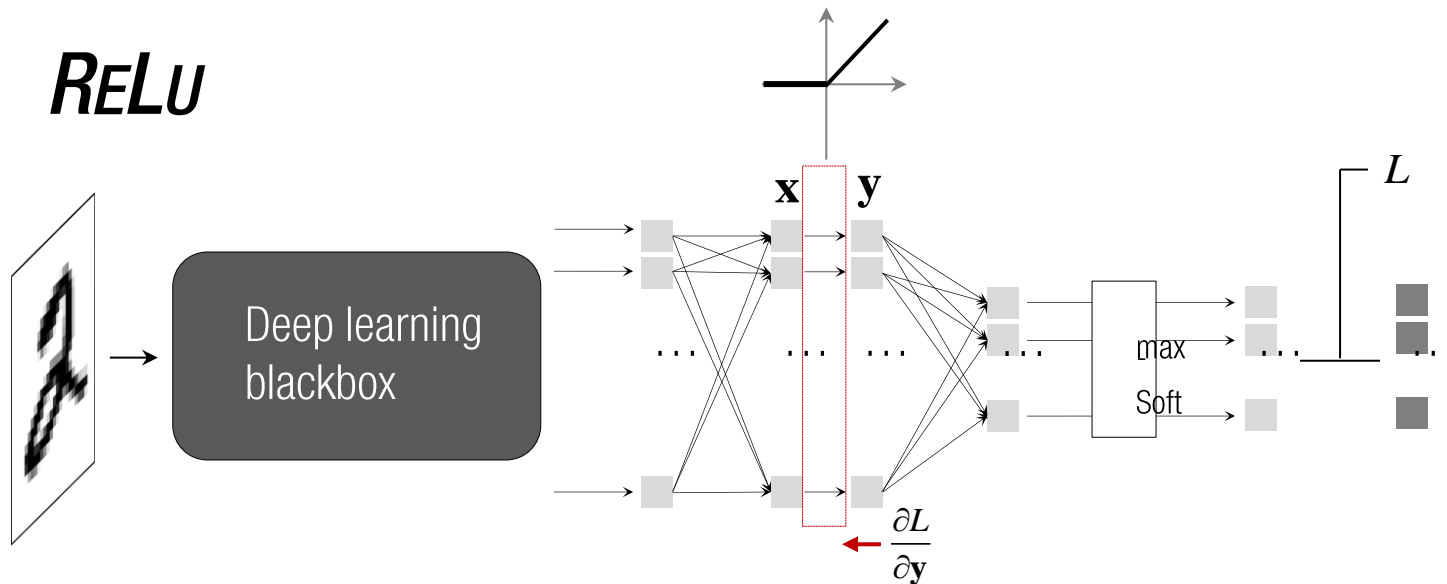

Input:

Trainable var.:

Output:

RELU

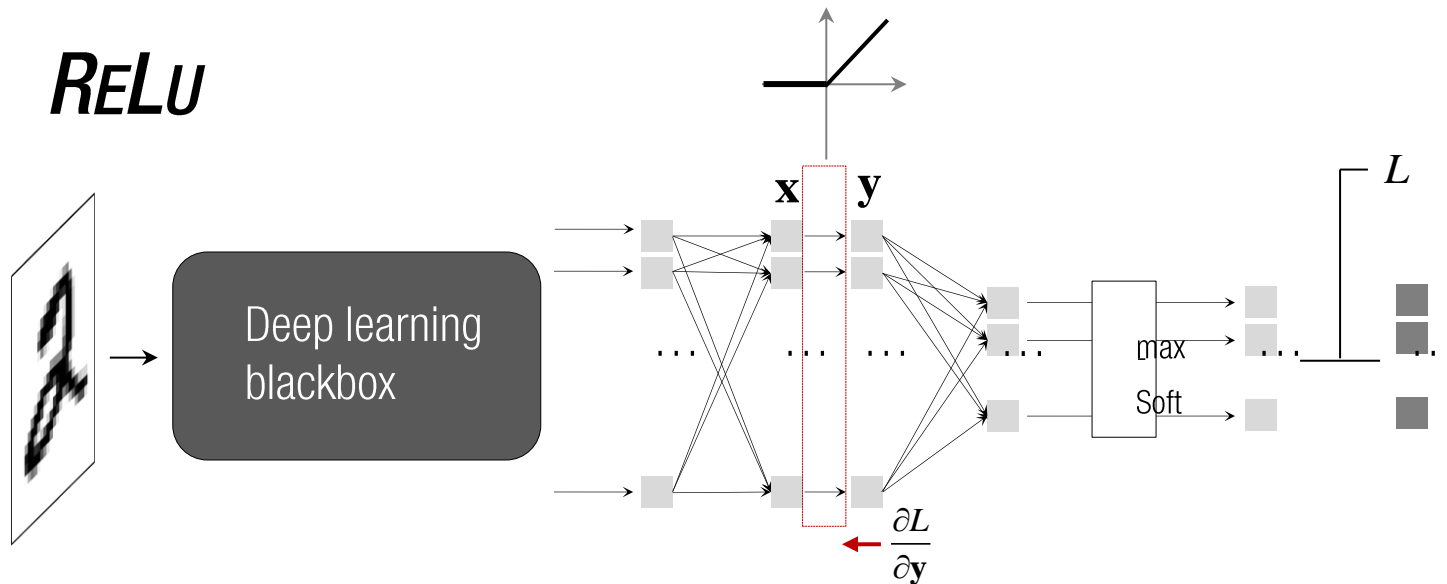

Input: $\mathbf{x} \in \mathbb{R}^n$

Trainable var.: None

Output: $\mathbf{y}_i = \max(0, \mathbf{x}_i)$
 $\mathbf{y} \in \mathbb{R}^n$

RELU

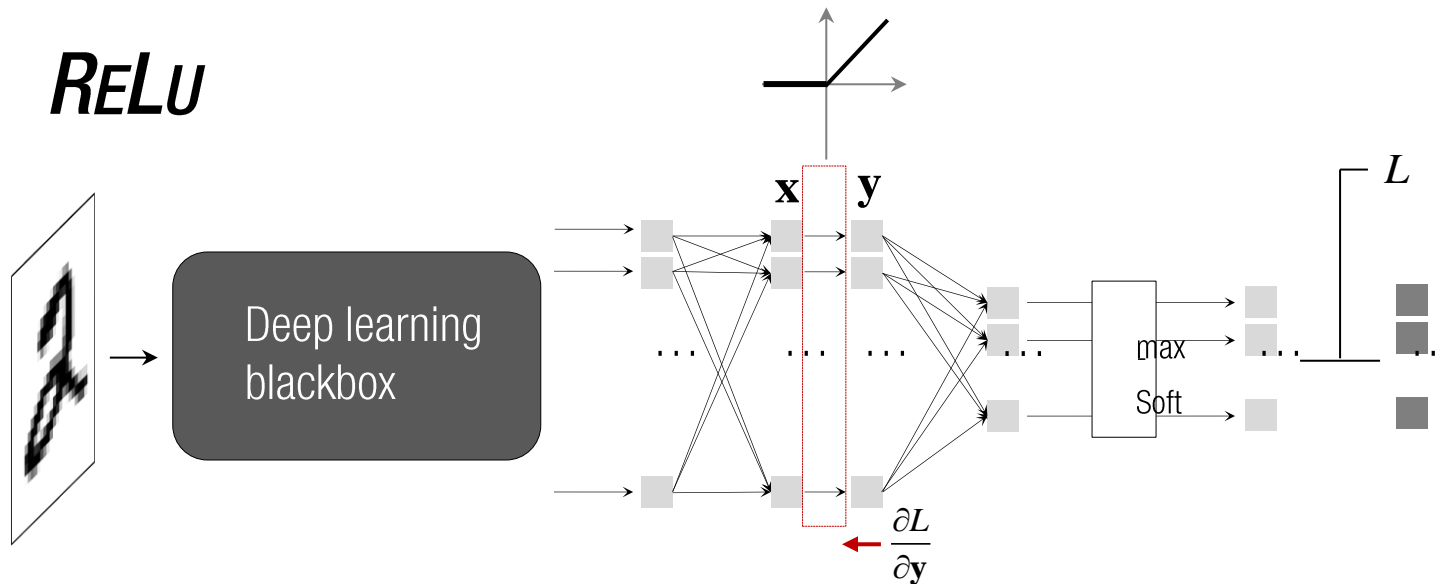

Input: $\mathbf{x} \in \mathbb{R}^n$

$$\frac{\partial L}{\partial \mathbf{x}_i} =$$

Trainable var.: None

Output: $\mathbf{y}_i = \max(0, \mathbf{x}_i)$
 $\mathbf{y} \in \mathbb{R}^n$

RELU

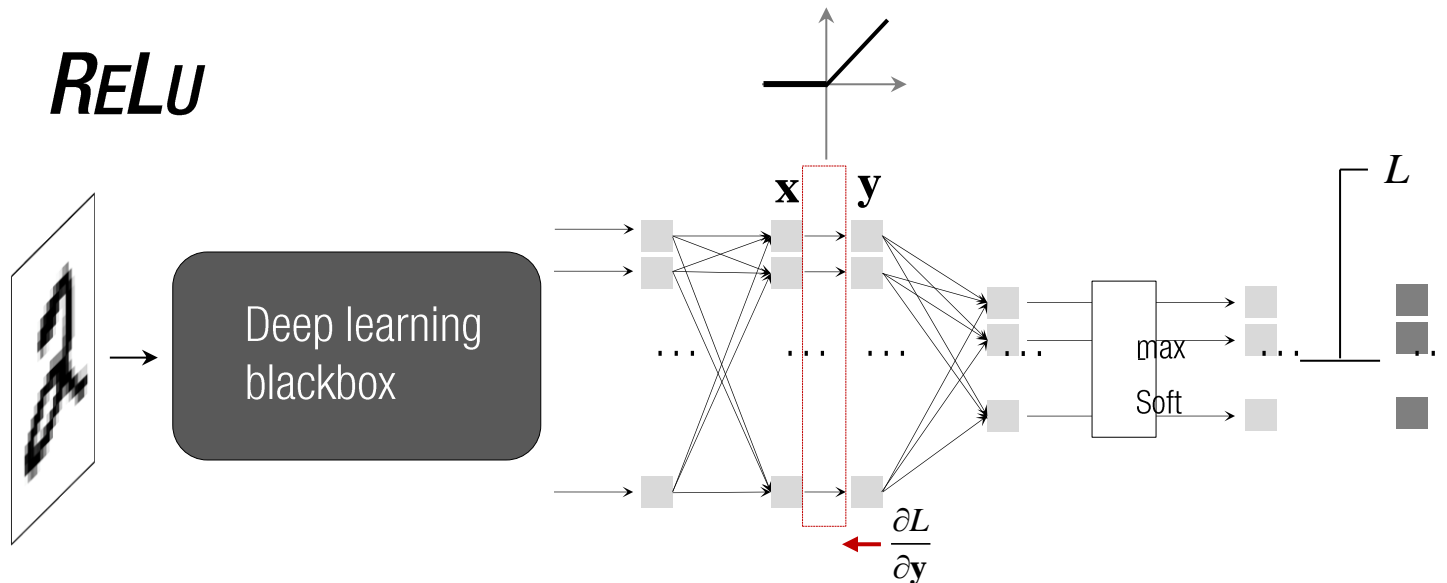

Input: $\mathbf{x} \in \mathbb{R}^n$

$$\frac{\partial L}{\partial \mathbf{x}_i} = \sum_j \frac{\partial L}{\partial \mathbf{y}_j} \frac{\partial}{\partial \mathbf{x}_i} \max(0, \mathbf{x}_j)$$

Trainable var.: None

Output: $\mathbf{y}_i = \max(0, \mathbf{x}_i)$
 $\mathbf{y} \in \mathbb{R}^n$

RELU

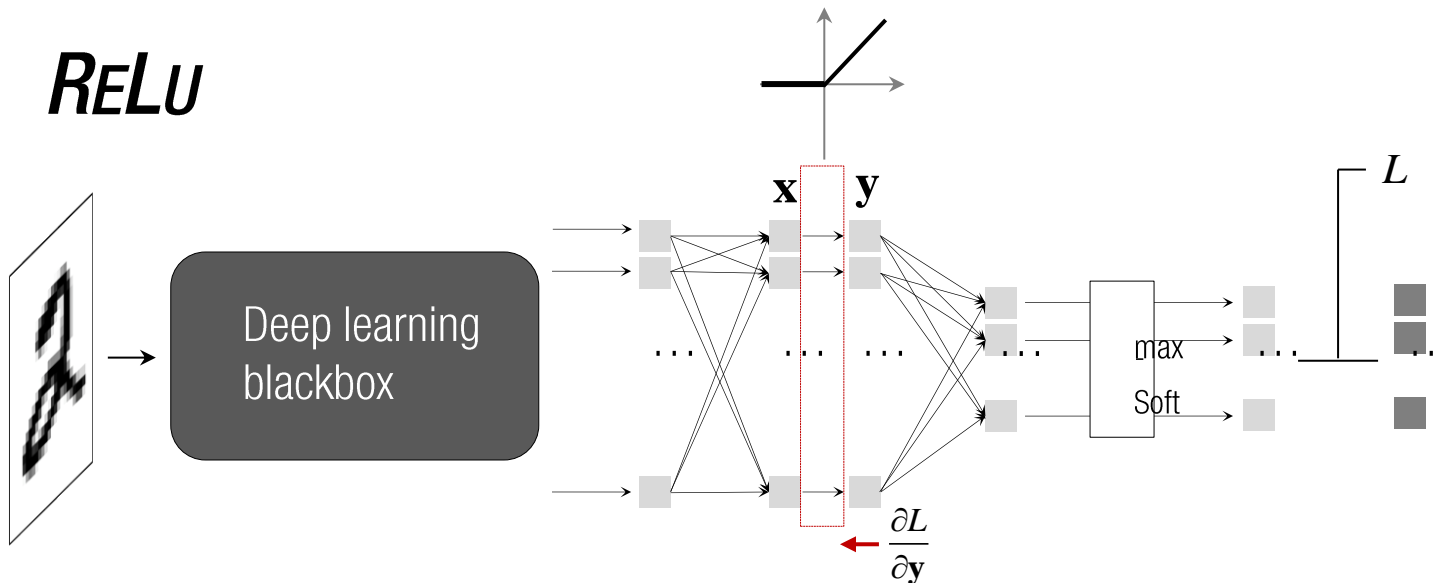

Input: $\mathbf{x} \in \mathbb{R}^n$

$$\frac{\partial L}{\partial \mathbf{x}_i} = \sum_j \frac{\partial L}{\partial \mathbf{y}_j} \frac{\partial}{\partial \mathbf{x}_i} \max(0, \mathbf{x}_j) = \frac{\partial L}{\partial \mathbf{y}_i} \frac{\partial}{\partial \mathbf{x}_i} \max(0, \mathbf{x}_i)$$

Trainable var.: None

Output: $\mathbf{y}_i = \max(0, \mathbf{x}_i)$
 $\mathbf{y} \in \mathbb{R}^n$

RELU

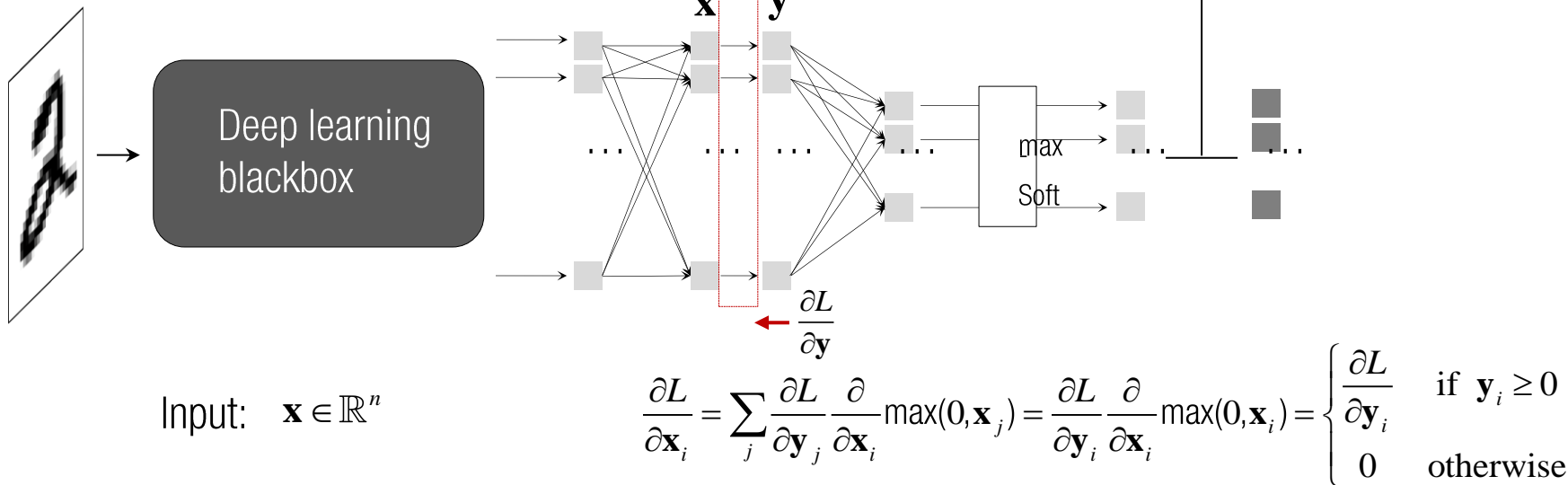

RELU

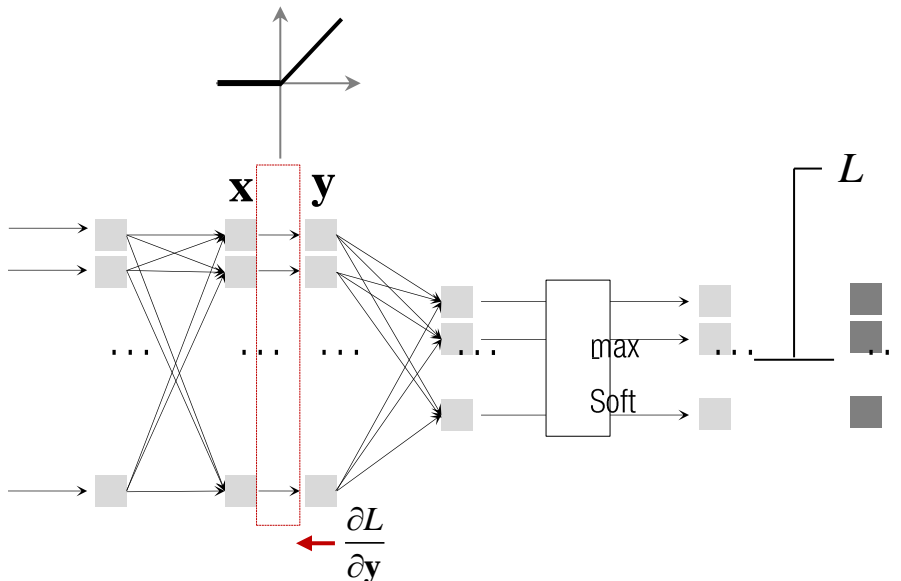
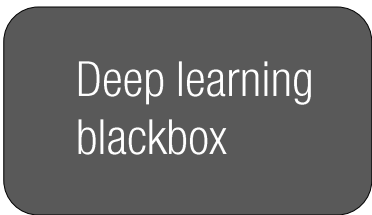
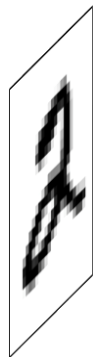

Input: $\mathbf{x} \in \mathbb{R}^n$

$$\frac{\partial L}{\partial \mathbf{x}_i} = \sum_j \frac{\partial L}{\partial \mathbf{y}_j} \frac{\partial}{\partial \mathbf{x}_i} \max(0, \mathbf{x}_j) = \frac{\partial L}{\partial \mathbf{y}_i} \frac{\partial}{\partial \mathbf{x}_i} \max(0, \mathbf{x}_i) = \begin{cases} \frac{\partial L}{\partial \mathbf{y}_i} & \text{if } \mathbf{y}_i \geq 0 \\ 0 & \text{otherwise} \end{cases}$$

Trainable var.: None

Output: $\mathbf{y}_i = \max(0, \mathbf{x}_i)$
 $\mathbf{y} \in \mathbb{R}^n$

function $[y] = \text{Relu}(x)$
 function $[dLdx] = \text{Relu_back}(dLdy, x, w, y)$

RECALL: ALEX NET

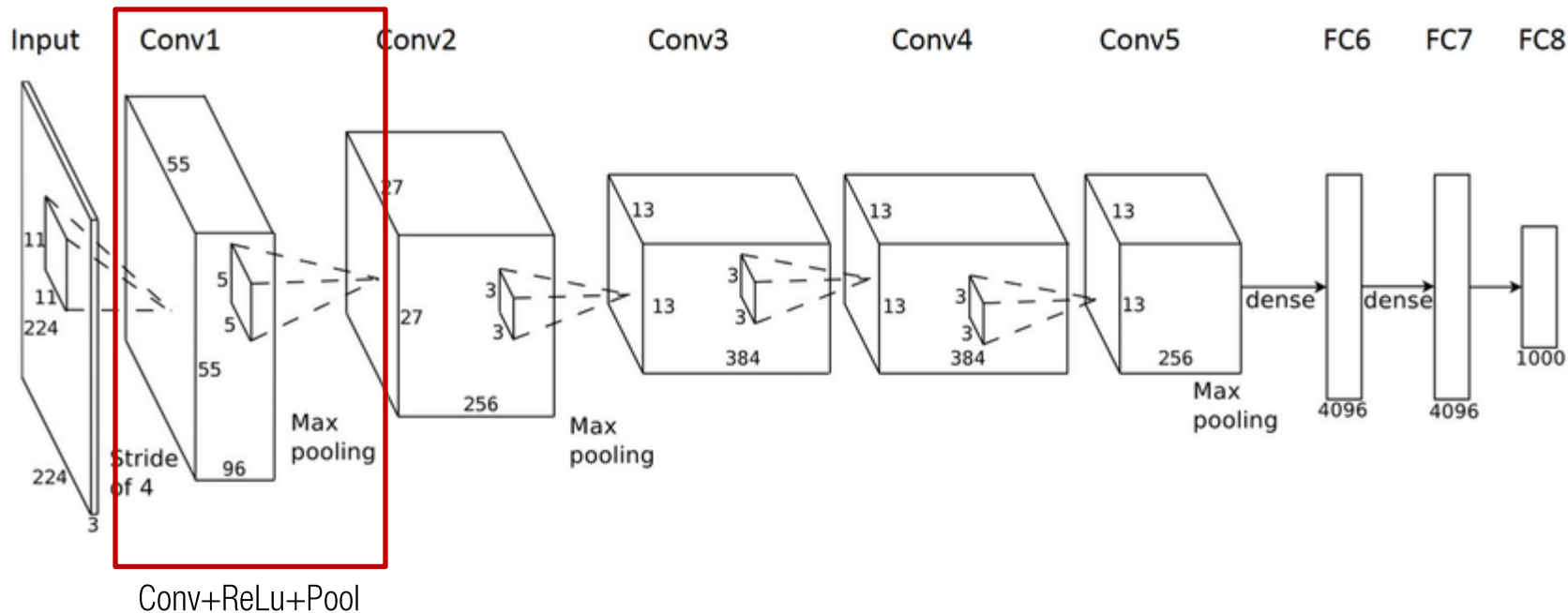

RECALL: CONV+RELU+POOL

Conv+ReLu layer

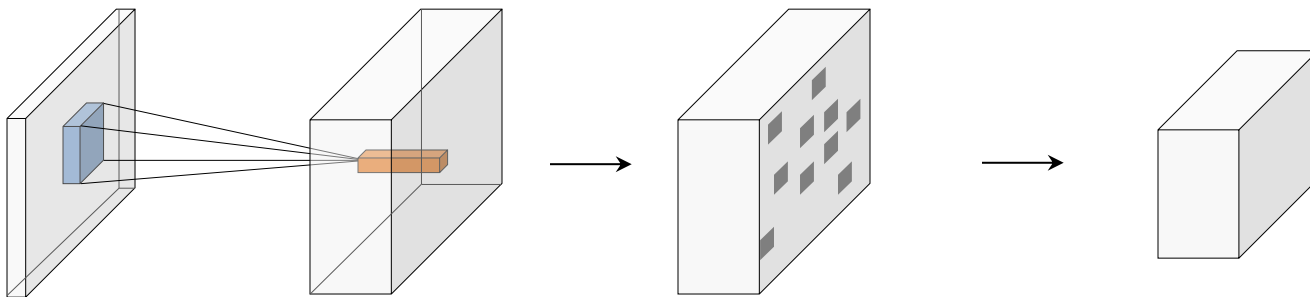

Operations:

Conv

ReLu

Max-pool

of units:

$$H \times W \times C_1$$

$$H \times W \times C_2$$

$$H \times W \times C_2$$

$$H_1 \times W_1 \times C_2$$

of weights:

$$F \times F \times C_1 \times C_2$$

0

0

of biases:

$$1 \times C_2$$

0

0

RECALL: SPATIAL POOLING

3	2	3	1
0	5	3	4
1	2	2	2
7	3	1	7

4×4

5	4
7	7

2×2

Max-pooling (window size 2x2, stride 2)

MAX-POOL

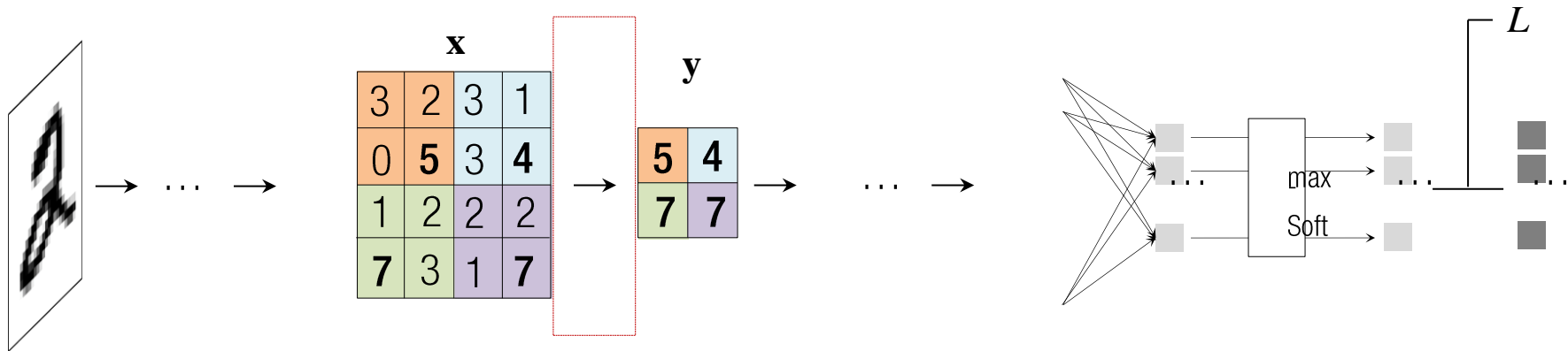

Input:

Trainable var.:

Output:

MAX-POOL

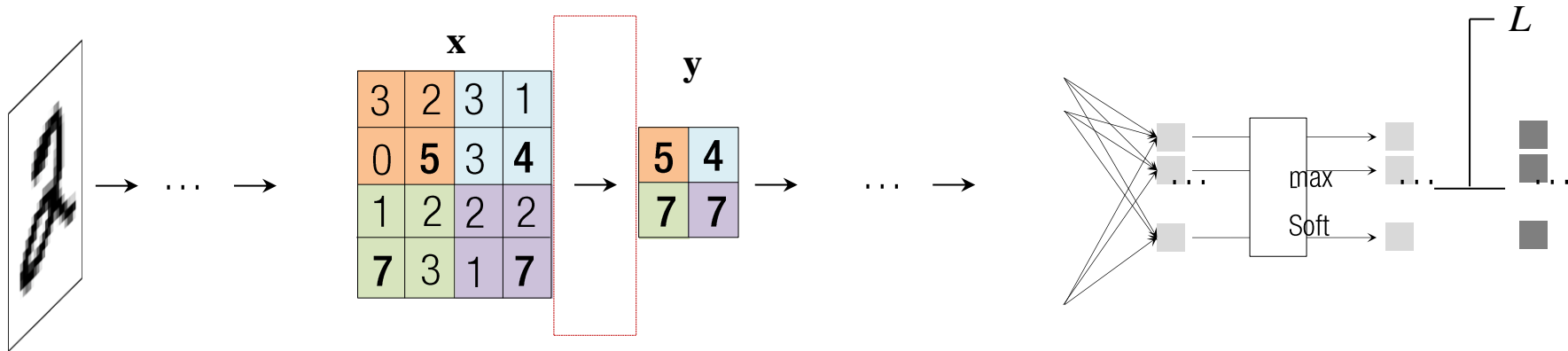

Input: $\mathbf{x} \in \mathbb{R}^{H \times W \times C}$

Trainable var.: None

Output: $\mathbf{y} \in \mathbb{R}^{\frac{H}{2} \times \frac{W}{2} \times C}$

MAX-POOL

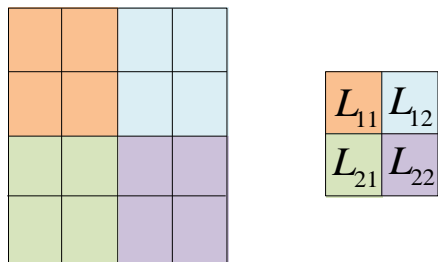
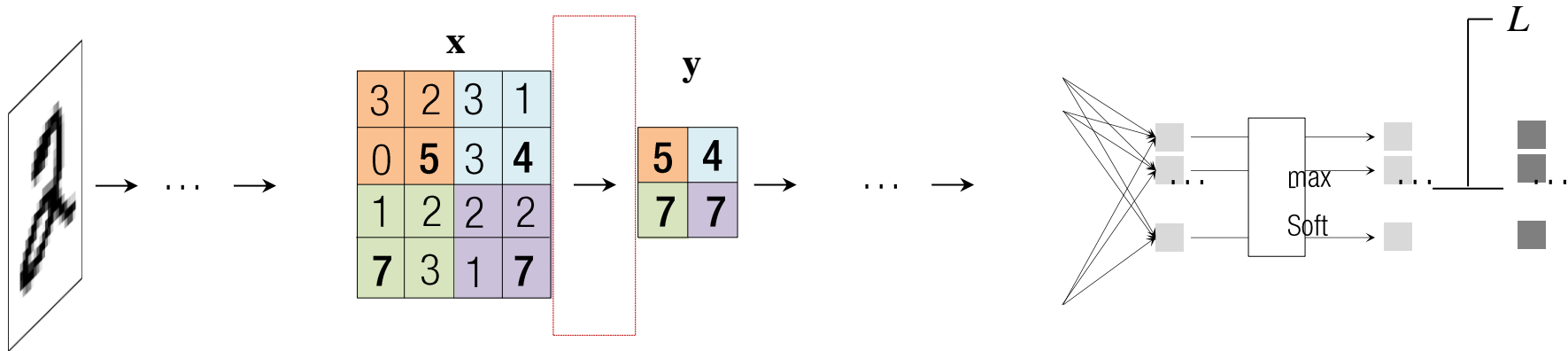

$$\leftarrow \frac{\partial L}{\partial \mathbf{x}}$$

$$\leftarrow \frac{\partial L}{\partial \mathbf{y}}$$

Input: $\mathbf{x} \in \mathbb{R}^{H \times W \times C}$

Trainable var.: None

Output: $\mathbf{y} \in \mathbb{R}^{\frac{H}{2} \times \frac{W}{2} \times C}$

MAX-POOL

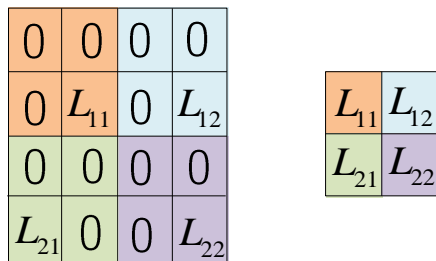
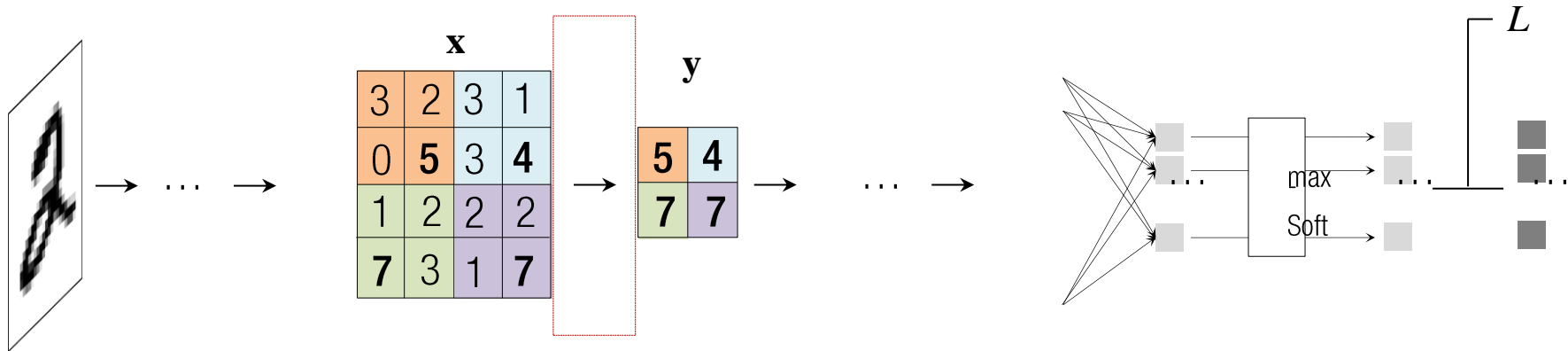

$$\leftarrow \frac{\partial L}{\partial \mathbf{x}}$$

$$\leftarrow \frac{\partial L}{\partial \mathbf{y}}$$

Input: $\mathbf{x} \in \mathbb{R}^{H \times W \times C}$

Trainable var.: None

Output: $\mathbf{y} \in \mathbb{R}^{\frac{H}{2} \times \frac{W}{2} \times C}$

MAX-POOL

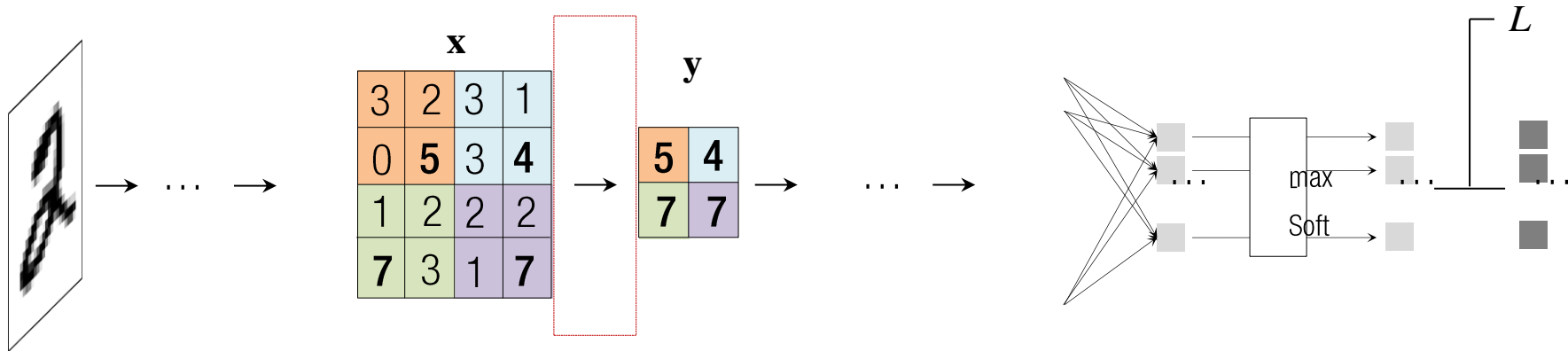

Input: $\mathbf{x} \in \mathbb{R}^{H \times W \times C}$

```
function [y] = Maxpool(x, size, stride)
function [dLdx] = Maxpool_back(dLdy, x, size, stride, y)
```

Trainable var.: None

Output: $\mathbf{y} \in \mathbb{R}^{\frac{H}{2} \times \frac{W}{2} \times C}$

CONVOLUTIONAL OPERATION

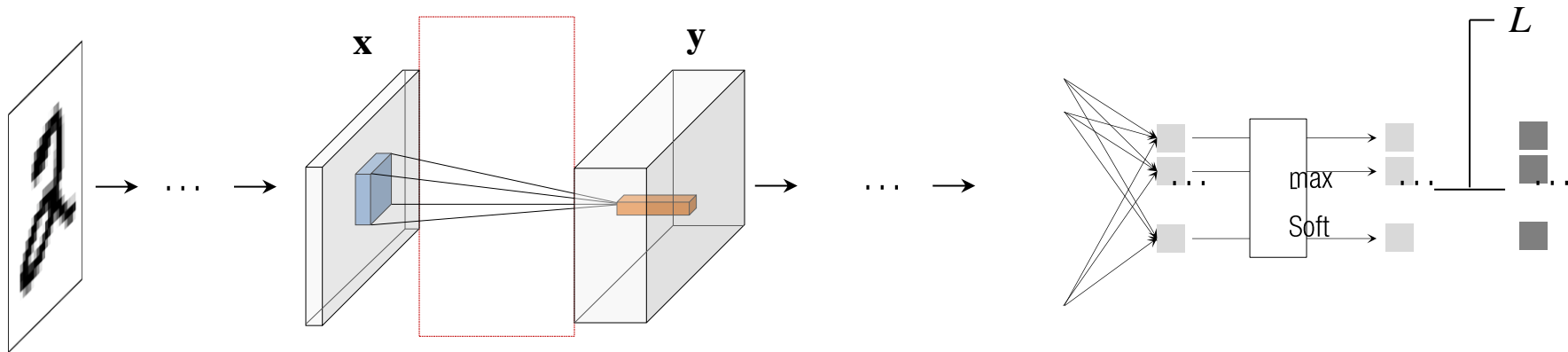

Input: $\mathbf{x} \in \mathbb{R}^{H \times W \times C_1}$

Trainable var.: $\mathbf{w} \in \mathbb{R}^{F \times F \times C_1 \times C_2}$

Output: $\mathbf{y} = \mathbf{x} * \mathbf{w}$
 $\mathbf{y} \in \mathbb{R}^{H \times W \times C_2}$

CONVOLUTIONAL OPERATION

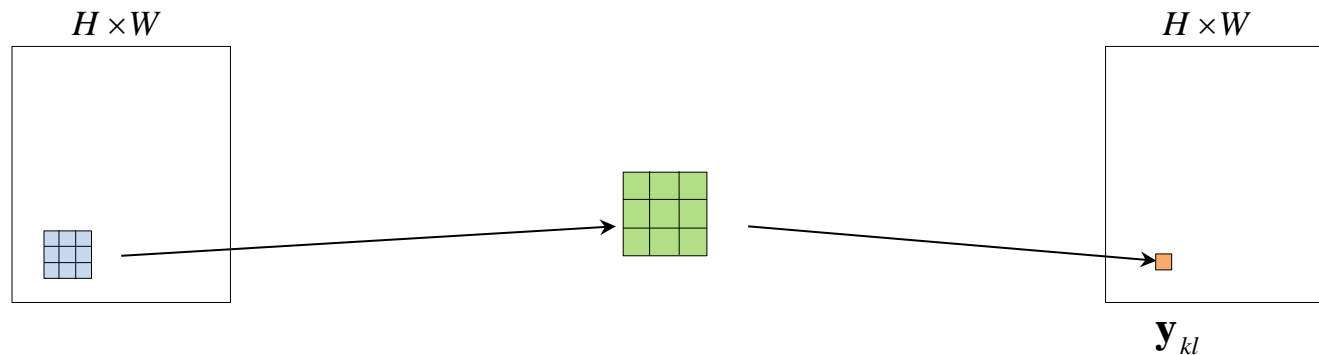

$$\mathbf{y}_{kl} = \sum_{i=k}^F \sum_{j=l}^F w_{i-k, j-l} x_{ij}$$

$$\frac{\partial \mathbf{y}_{kl}}{\partial \mathbf{x}_{ij}} = \mathbf{w}$$

CONVOLUTIONAL OPERATION

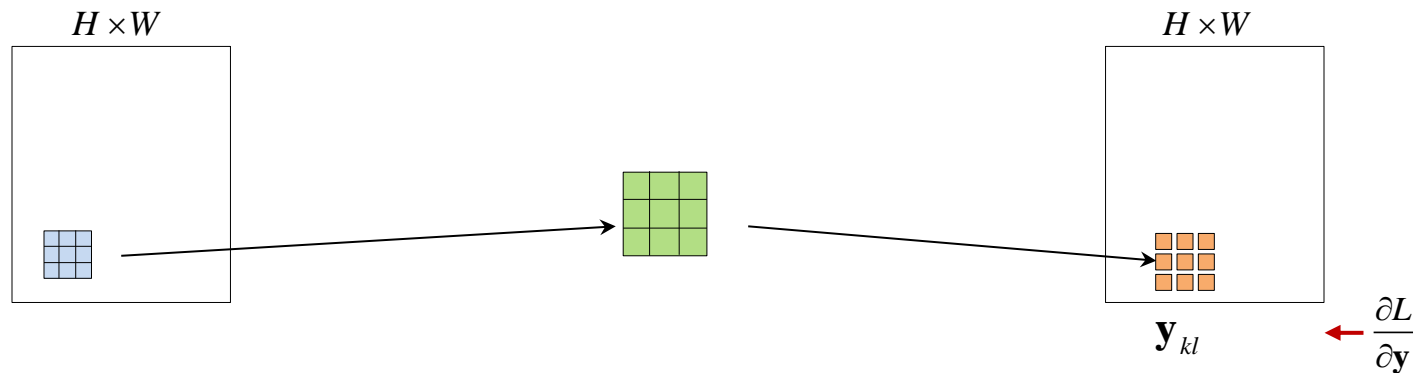

$$\mathbf{y}_{kl} = \sum_{i=k}^F \sum_{j=l}^F w_{i-k, j-l} \mathbf{x}_{ij}$$

$$\frac{\partial \mathbf{y}_{kl}}{\partial \mathbf{x}_{ij}} = \mathbf{w}$$

$$\frac{\partial L}{\partial \mathbf{x}_{ij}} = \sum_k \sum_l \frac{\partial L}{\partial \mathbf{y}_{kl}} \frac{\partial \mathbf{y}_{kl}}{\partial \mathbf{x}_{ij}}$$

CONVOLUTIONAL OPERATION

\mathbf{x}_{11}	\mathbf{x}_{12}	\mathbf{x}_{13}
\mathbf{x}_{21}	\mathbf{x}_{22}	\mathbf{x}_{23}
\mathbf{x}_{31}	\mathbf{x}_{32}	\mathbf{x}_{33}

\mathbf{w}_{11}	\mathbf{w}_{12}	\mathbf{w}_{13}
\mathbf{w}_{21}	\mathbf{w}_{22}	\mathbf{w}_{23}
\mathbf{w}_{31}	\mathbf{w}_{32}	\mathbf{w}_{33}

L_{11}	L_{12}	L_{13}
L_{21}	L_{22}	L_{23}
L_{31}	L_{32}	L_{33}

$$\leftarrow \frac{\partial L}{\partial \mathbf{y}}$$

$$\frac{\partial L}{\partial \mathbf{x}_{ij}} = \sum_k \sum_l \frac{\partial L}{\partial \mathbf{y}_{kl}} \frac{\partial \mathbf{y}_{kl}}{\partial \mathbf{x}_{ij}}$$

CONVOLUTIONAL OPERATION

\mathbf{x}_{11}	\mathbf{x}_{12}	\mathbf{x}_{13}
\mathbf{x}_{21}	\mathbf{x}_{22}	\mathbf{x}_{23}
\mathbf{x}_{31}	\mathbf{x}_{32}	\mathbf{x}_{33}

\mathbf{w}_{11}	\mathbf{w}_{12}	\mathbf{w}_{13}
\mathbf{w}_{21}	\mathbf{w}_{22}	\mathbf{w}_{23}
\mathbf{w}_{31}	\mathbf{w}_{32}	\mathbf{w}_{33}

$$\mathbf{y}_{11} = \mathbf{w}_{11}\mathbf{x}_{11} + \dots + \mathbf{w}_{33}\mathbf{x}_{33}$$

\mathbf{y}_{11}		

L_{11}	L_{12}	L_{13}
L_{21}	L_{22}	L_{23}
L_{31}	L_{32}	L_{33}

$$\leftarrow \frac{\partial L}{\partial \mathbf{y}}$$

$$\frac{\partial L}{\partial \mathbf{x}_{ij}} = \sum_k \sum_l \frac{\partial L}{\partial \mathbf{y}_{kl}} \frac{\partial \mathbf{y}_{kl}}{\partial \mathbf{x}_{ij}}$$

CONVOLUTIONAL OPERATION

\mathbf{x}_{11}	\mathbf{x}_{12}	\mathbf{x}_{13}
\mathbf{x}_{21}	\mathbf{x}_{22}	\mathbf{x}_{23}
\mathbf{x}_{31}	\mathbf{x}_{32}	\mathbf{x}_{33}

\mathbf{w}_{11}	\mathbf{w}_{12}	\mathbf{w}_{13}
\mathbf{w}_{21}	\mathbf{w}_{22}	\mathbf{w}_{23}
\mathbf{w}_{31}	\mathbf{w}_{32}	\mathbf{w}_{33}

$$\mathbf{y}_{11} = \mathbf{w}_{11}\mathbf{x}_{00} + \dots + \mathbf{w}_{33}\mathbf{x}_{22}$$

$$\frac{\partial \mathbf{y}_{11}}{\partial \mathbf{x}_{22}} = \mathbf{w}_{33}$$

\mathbf{y}_{11}		

L_{11}	L_{12}	L_{13}
L_{21}	L_{22}	L_{23}
L_{31}	L_{32}	L_{33}

$$\leftarrow \frac{\partial L}{\partial \mathbf{y}}$$

$$\frac{\partial L}{\partial \mathbf{x}_{ij}} = \sum_k \sum_l \frac{\partial L}{\partial \mathbf{y}_{kl}} \frac{\partial \mathbf{y}_{kl}}{\partial \mathbf{x}_{ij}}$$

CONVOLUTIONAL OPERATION

\mathbf{x}_{11}	\mathbf{x}_{12}	\mathbf{x}_{13}
\mathbf{x}_{21}	\mathbf{x}_{22}	\mathbf{x}_{23}
\mathbf{x}_{31}	\mathbf{x}_{32}	\mathbf{x}_{33}

\mathbf{w}_{11}	\mathbf{w}_{12}	\mathbf{w}_{13}
\mathbf{w}_{21}	\mathbf{w}_{22}	\mathbf{w}_{23}
\mathbf{w}_{31}	\mathbf{w}_{32}	\mathbf{w}_{33}

\mathbf{y}_{11}		

L_{11}	L_{12}	L_{13}
L_{21}	L_{22}	L_{23}
L_{31}	L_{32}	L_{33}

$\leftarrow \frac{\partial L}{\partial \mathbf{y}}$

$$\mathbf{y}_{11} = \mathbf{w}_{11}\mathbf{x}_{00} + \dots + \mathbf{w}_{33}\mathbf{x}_{22}$$

$$\frac{\partial \mathbf{y}_{11}}{\partial \mathbf{x}_{22}} = \mathbf{w}_{33}$$

$$\frac{\partial L}{\partial \mathbf{y}_{11}} \frac{\partial \mathbf{y}_{11}}{\partial \mathbf{x}_{22}} = L_{11} \mathbf{w}_{33}$$

$$\frac{\partial L}{\partial \mathbf{x}_{ij}} = \sum_k \sum_l \frac{\partial L}{\partial \mathbf{y}_{kl}} \frac{\partial \mathbf{y}_{kl}}{\partial \mathbf{x}_{ij}}$$

CONVOLUTIONAL OPERATION

\mathbf{x}_{11}	\mathbf{x}_{12}	\mathbf{x}_{13}
\mathbf{x}_{21}	\mathbf{x}_{22}	\mathbf{x}_{23}
\mathbf{x}_{31}	\mathbf{x}_{32}	\mathbf{x}_{33}

\mathbf{w}_{11}	\mathbf{w}_{12}	\mathbf{w}_{13}
\mathbf{w}_{21}	\mathbf{w}_{22}	\mathbf{w}_{23}
\mathbf{w}_{31}	\mathbf{w}_{32}	\mathbf{w}_{33}

\mathbf{y}_{11}	\mathbf{y}_{12}	

L_{11}	L_{12}	L_{13}
L_{21}	L_{22}	L_{23}
L_{31}	L_{32}	L_{33}

$$\leftarrow \frac{\partial L}{\partial \mathbf{y}}$$

$$\mathbf{y}_{11} = \mathbf{w}_{11}\mathbf{x}_{00} + \dots + \mathbf{w}_{33}\mathbf{x}_{22}$$

$$\mathbf{y}_{12} = \mathbf{w}_{11}\mathbf{x}_{01} + \dots + \mathbf{w}_{33}\mathbf{x}_{23}$$

$$\frac{\partial \mathbf{y}_{11}}{\partial \mathbf{x}_{22}} = \mathbf{w}_{33}$$

$$\frac{\partial \mathbf{y}_{12}}{\partial \mathbf{x}_{22}} = \mathbf{w}_{32}$$

$$\frac{\partial L}{\partial \mathbf{y}_{11}} \frac{\partial \mathbf{y}_{11}}{\partial \mathbf{x}_{22}} = L_{11}\mathbf{w}_{33}$$

$$\frac{\partial L}{\partial \mathbf{y}_{12}} \frac{\partial \mathbf{y}_{12}}{\partial \mathbf{x}_{22}} = L_{12}\mathbf{w}_{32}$$

$$\frac{\partial L}{\partial \mathbf{x}_{ij}} = \sum_k \sum_l \frac{\partial L}{\partial \mathbf{y}_{kl}} \frac{\partial \mathbf{y}_{kl}}{\partial \mathbf{x}_{ij}}$$

CONVOLUTIONAL OPERATION

$$\leftarrow \frac{\partial L}{\partial \mathbf{y}}$$

\mathbf{x}_{11}	\mathbf{x}_{12}	\mathbf{x}_{13}
\mathbf{x}_{21}	\mathbf{x}_{22}	\mathbf{x}_{23}
\mathbf{x}_{31}	\mathbf{x}_{32}	\mathbf{x}_{33}

\mathbf{w}_{11}	\mathbf{w}_{12}	\mathbf{w}_{13}
\mathbf{w}_{21}	\mathbf{w}_{22}	\mathbf{w}_{23}
\mathbf{w}_{31}	\mathbf{w}_{32}	\mathbf{w}_{33}

\mathbf{y}_{11}	\mathbf{y}_{12}	\mathbf{y}_{13}
\mathbf{y}_{21}	\mathbf{y}_{22}	

L_{11}	L_{12}	L_{13}
L_{21}	L_{22}	L_{23}
L_{31}	L_{32}	L_{33}

$$\mathbf{y}_{11} = \mathbf{w}_{11}\mathbf{x}_{00} + \dots + \mathbf{w}_{33}\mathbf{x}_{22}$$

$$\mathbf{y}_{12} = \mathbf{w}_{11}\mathbf{x}_{01} + \dots + \mathbf{w}_{33}\mathbf{x}_{23}$$

$$\mathbf{y}_{22} = \mathbf{w}_{11}\mathbf{x}_{11} + \dots + \mathbf{w}_{33}\mathbf{x}_{33}$$

$$\frac{\partial \mathbf{y}_{11}}{\partial \mathbf{x}_{22}} = \mathbf{w}_{33}$$

$$\frac{\partial \mathbf{y}_{12}}{\partial \mathbf{x}_{22}} = \mathbf{w}_{32}$$

$$\frac{\partial \mathbf{y}_{22}}{\partial \mathbf{x}_{22}} = \mathbf{w}_{22}$$

$$\frac{\partial L}{\partial \mathbf{y}_{11}} \frac{\partial \mathbf{y}_{11}}{\partial \mathbf{x}_{22}} = L_{11} \mathbf{w}_{33}$$

$$\frac{\partial L}{\partial \mathbf{y}_{12}} \frac{\partial \mathbf{y}_{12}}{\partial \mathbf{x}_{22}} = L_{12} \mathbf{w}_{32}$$

$$\frac{\partial L}{\partial \mathbf{y}_{22}} \frac{\partial \mathbf{y}_{22}}{\partial \mathbf{x}_{22}} = L_{22} \mathbf{w}_{22}$$

$$\frac{\partial L}{\partial \mathbf{x}_{ij}} = \sum_k \sum_l \frac{\partial L}{\partial \mathbf{y}_{kl}} \frac{\partial \mathbf{y}_{kl}}{\partial \mathbf{x}_{ij}}$$

CONVOLUTIONAL OPERATION

$$\leftarrow \frac{\partial L}{\partial \mathbf{y}}$$

\mathbf{x}_{11}	\mathbf{x}_{12}	\mathbf{x}_{13}
\mathbf{x}_{21}	\mathbf{x}_{22}	\mathbf{x}_{23}
\mathbf{x}_{31}	\mathbf{x}_{32}	\mathbf{x}_{33}

\mathbf{w}_{11}	\mathbf{w}_{12}	\mathbf{w}_{13}
\mathbf{w}_{21}	\mathbf{w}_{22}	\mathbf{w}_{23}
\mathbf{w}_{31}	\mathbf{w}_{32}	\mathbf{w}_{33}

\mathbf{y}_{11}	\mathbf{y}_{12}	\mathbf{y}_{13}
\mathbf{y}_{21}	\mathbf{y}_{22}	\mathbf{y}_{23}
\mathbf{y}_{31}	\mathbf{y}_{32}	\mathbf{y}_{33}

L_{11}	L_{12}	L_{13}
L_{21}	L_{22}	L_{23}
L_{31}	L_{32}	L_{33}

$$\mathbf{y}_{11} = \mathbf{w}_{11}\mathbf{x}_{00} + \dots + \mathbf{w}_{33}\mathbf{x}_{22}$$

$$\mathbf{y}_{12} = \mathbf{w}_{11}\mathbf{x}_{01} + \dots + \mathbf{w}_{33}\mathbf{x}_{23}$$

$$\mathbf{y}_{22} = \mathbf{w}_{11}\mathbf{x}_{11} + \dots + \mathbf{w}_{33}\mathbf{x}_{33}$$

$$\mathbf{y}_{33} = \mathbf{w}_{11}\mathbf{x}_{22} + \dots + \mathbf{w}_{33}\mathbf{x}_{44}$$

$$\frac{\partial \mathbf{y}_{11}}{\partial \mathbf{x}_{22}} = \mathbf{w}_{33}$$

$$\frac{\partial \mathbf{y}_{12}}{\partial \mathbf{x}_{22}} = \mathbf{w}_{32}$$

$$\frac{\partial \mathbf{y}_{22}}{\partial \mathbf{x}_{22}} = \mathbf{w}_{22}$$

$$\frac{\partial \mathbf{y}_{33}}{\partial \mathbf{x}_{22}} = \mathbf{w}_{11}$$

$$\frac{\partial L}{\partial \mathbf{y}_{11}} \frac{\partial \mathbf{y}_{11}}{\partial \mathbf{x}_{22}} = L_{11}\mathbf{w}_{33}$$

$$\frac{\partial L}{\partial \mathbf{y}_{12}} \frac{\partial \mathbf{y}_{12}}{\partial \mathbf{x}_{22}} = L_{12}\mathbf{w}_{32}$$

$$\frac{\partial L}{\partial \mathbf{y}_{22}} \frac{\partial \mathbf{y}_{22}}{\partial \mathbf{x}_{22}} = L_{22}\mathbf{w}_{22}$$

$$\frac{\partial L}{\partial \mathbf{y}_{33}} \frac{\partial \mathbf{y}_{33}}{\partial \mathbf{x}_{22}} = L_{33}\mathbf{w}_{11}$$

$$\frac{\partial L}{\partial \mathbf{x}_{ij}} = \sum_k \sum_l \frac{\partial L}{\partial \mathbf{y}_{kl}} \frac{\partial \mathbf{y}_{kl}}{\partial \mathbf{x}_{ij}}$$

CONVOLUTIONAL OPERATION

\mathbf{x}_{11}	\mathbf{x}_{12}	\mathbf{x}_{13}
\mathbf{x}_{21}	\mathbf{x}_{22}	\mathbf{x}_{23}
\mathbf{x}_{31}	\mathbf{x}_{32}	\mathbf{x}_{33}

\mathbf{w}_{11}	\mathbf{w}_{12}	\mathbf{w}_{13}
\mathbf{w}_{21}	\mathbf{w}_{22}	\mathbf{w}_{23}
\mathbf{w}_{31}	\mathbf{w}_{32}	\mathbf{w}_{33}

\mathbf{y}_{11}	\mathbf{y}_{12}	\mathbf{y}_{13}
\mathbf{y}_{21}	\mathbf{y}_{22}	\mathbf{y}_{23}
\mathbf{y}_{31}	\mathbf{y}_{32}	\mathbf{y}_{33}

L_{11}	L_{12}	L_{13}
L_{21}	L_{22}	L_{23}
L_{31}	L_{32}	L_{33}

$$\frac{\partial L}{\partial \mathbf{y}_{11}} \frac{\partial \mathbf{y}_{11}}{\partial \mathbf{x}_{22}} = L_{11} \mathbf{w}_{33}$$

...

$$\frac{\partial L}{\partial \mathbf{y}_{33}} \frac{\partial \mathbf{y}_{33}}{\partial \mathbf{x}_{22}} = L_{33} \mathbf{w}_{11}$$

$$\frac{\partial L}{\partial \mathbf{x}_{ij}} = \sum_m \sum_n L_{mn} \mathbf{w}_{m-i, n-j}$$

CONVOLUTIONAL OPERATION

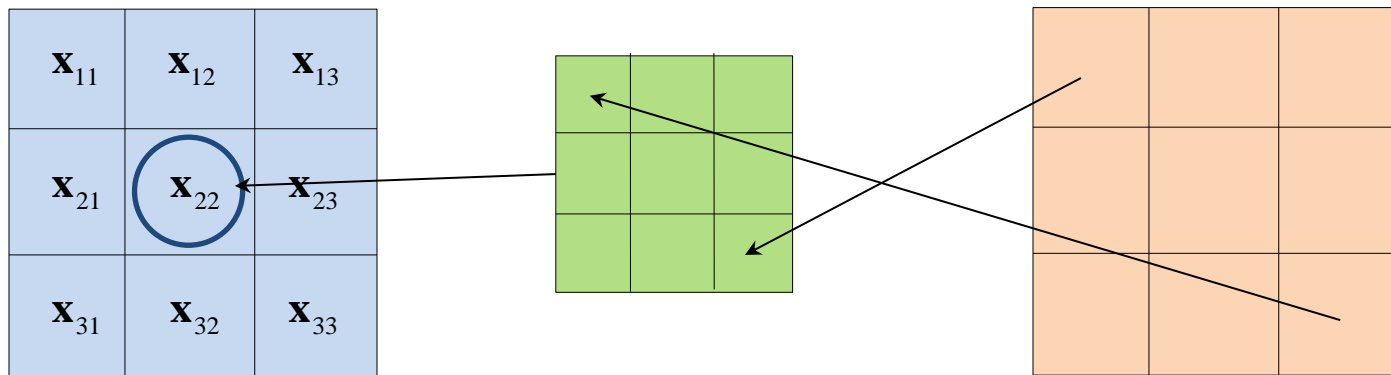

$$\frac{\partial L}{\partial y_{11}} \frac{\partial y_{11}}{\partial x_{22}} = L_{11} w_{33}$$

...

$$\frac{\partial L}{\partial y_{33}} \frac{\partial y_{33}}{\partial x_{22}} = L_{33} w_{11}$$

$$\frac{\partial L}{\partial x_{ij}} = \sum_m \sum_n L_{mn} w_{m-i, n-j}$$

CONVOLUTIONAL OPERATION

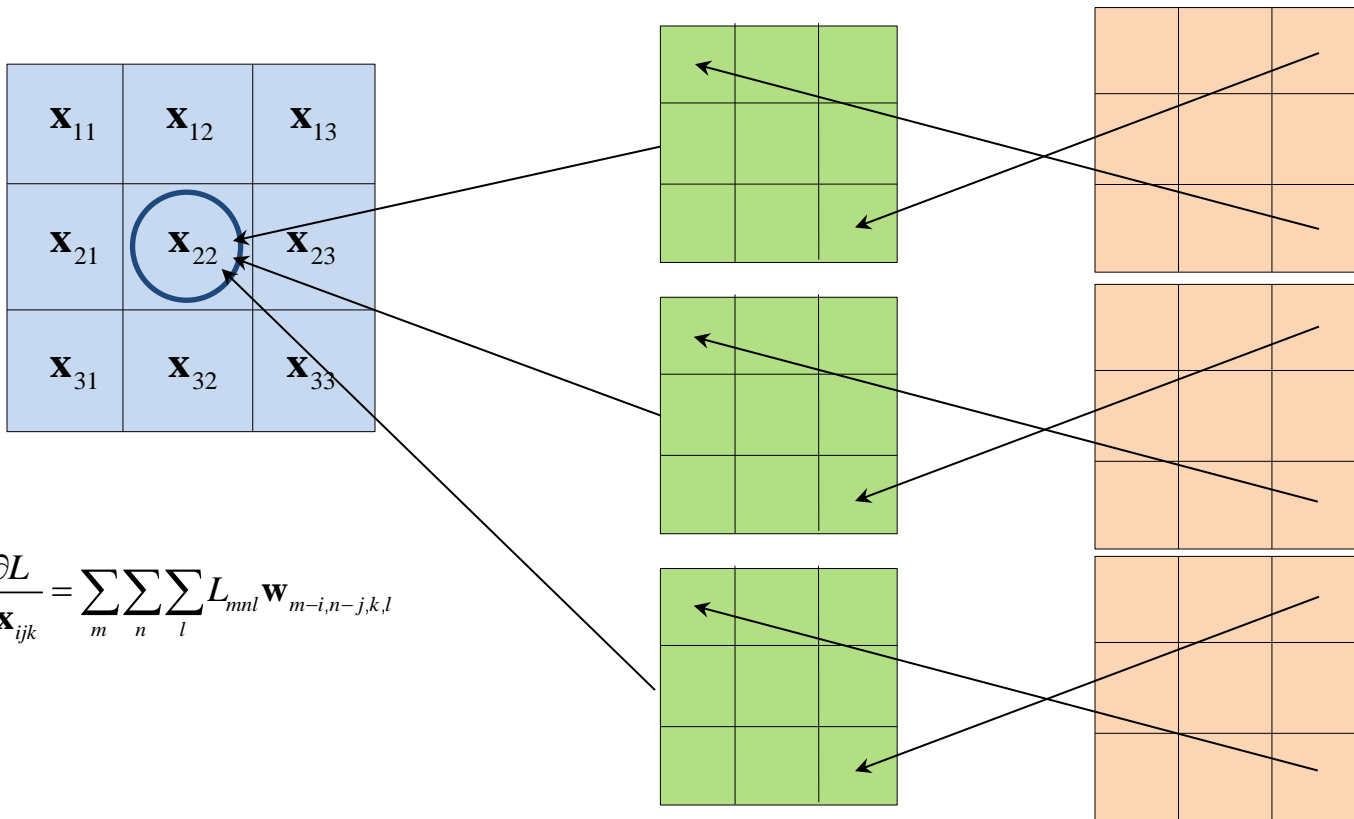

$$\frac{\partial L}{\partial \mathbf{x}_{ijk}} = \sum_m \sum_n \sum_l L_{mnl} \mathbf{w}_{m-i, n-j, k, l}$$

CONVOLUTIONAL OPERATION

\mathbf{x}_{11}	\mathbf{x}_{12}	\mathbf{x}_{13}
\mathbf{x}_{21}	\mathbf{x}_{22}	\mathbf{x}_{23}
\mathbf{x}_{31}	\mathbf{x}_{32}	\mathbf{x}_{33}

\mathbf{w}_{11}	\mathbf{w}_{12}	\mathbf{w}_{13}
\mathbf{w}_{21}	\mathbf{w}_{22}	\mathbf{w}_{23}
\mathbf{w}_{31}	\mathbf{w}_{32}	\mathbf{w}_{33}

\mathbf{y}_{11}	\mathbf{y}_{12}	\mathbf{y}_{13}
\mathbf{y}_{21}	\mathbf{y}_{22}	\mathbf{y}_{23}
\mathbf{y}_{31}	\mathbf{y}_{32}	\mathbf{y}_{33}

L_{11}	L_{12}	L_{13}
L_{21}	L_{22}	L_{23}
L_{31}	L_{32}	L_{33}

$\leftarrow \frac{\partial L}{\partial \mathbf{y}}$

$$\mathbf{y}_{11} = \mathbf{w}_{11}\mathbf{x}_{00} + \dots + \mathbf{w}_{33}\mathbf{x}_{22}$$

$$\frac{\partial \mathbf{y}_{11}}{\partial \mathbf{w}_{22}} = \mathbf{x}_{11}$$

$$\frac{\partial L}{\partial \mathbf{y}_{11}} \frac{\partial \mathbf{y}_{11}}{\partial \mathbf{w}_{22}} = L_{11}\mathbf{x}_{11}$$

$$\frac{\partial L}{\partial \mathbf{w}_{ij}} = \sum_k \sum_l \frac{\partial L}{\partial \mathbf{y}_{kl}} \frac{\partial \mathbf{y}_{kl}}{\partial \mathbf{w}_{ij}}$$

CONVOLUTIONAL OPERATION

\mathbf{x}_{11}	\mathbf{x}_{12}	\mathbf{x}_{13}
\mathbf{x}_{21}	\mathbf{x}_{22}	\mathbf{x}_{23}
\mathbf{x}_{31}	\mathbf{x}_{32}	\mathbf{x}_{33}

\mathbf{w}_{11}	\mathbf{w}_{12}	\mathbf{w}_{13}
\mathbf{w}_{21}	\mathbf{w}_{22}	\mathbf{w}_{23}
\mathbf{w}_{31}	\mathbf{w}_{32}	\mathbf{w}_{33}

\mathbf{y}_{11}	\mathbf{y}_{12}	\mathbf{y}_{13}
\mathbf{y}_{21}	\mathbf{y}_{22}	\mathbf{y}_{23}
\mathbf{y}_{31}	\mathbf{y}_{32}	\mathbf{y}_{33}

L_{11}	L_{12}	L_{13}
L_{21}	L_{22}	L_{23}
L_{31}	L_{32}	L_{33}

$\leftarrow \frac{\partial L}{\partial \mathbf{y}}$

$$\mathbf{y}_{11} = \mathbf{w}_{11}\mathbf{x}_{00} + \dots + \mathbf{w}_{33}\mathbf{x}_{22}$$

$$\mathbf{y}_{12} = \mathbf{w}_{11}\mathbf{x}_{01} + \dots + \mathbf{w}_{33}\mathbf{x}_{23}$$

$$\frac{\partial \mathbf{y}_{11}}{\partial \mathbf{w}_{22}} = \mathbf{x}_{11}$$

$$\frac{\partial \mathbf{y}_{12}}{\partial \mathbf{w}_{22}} = \mathbf{x}_{12}$$

$$\frac{\partial L}{\partial \mathbf{y}_{11}} \frac{\partial \mathbf{y}_{11}}{\partial \mathbf{w}_{22}} = L_{11}\mathbf{x}_{11}$$

$$\frac{\partial L}{\partial \mathbf{y}_{12}} \frac{\partial \mathbf{y}_{12}}{\partial \mathbf{w}_{22}} = L_{12}\mathbf{x}_{12}$$

$$\frac{\partial L}{\partial \mathbf{w}_{ij}} = \sum_k \sum_l \frac{\partial L}{\partial \mathbf{y}_{kl}} \frac{\partial \mathbf{y}_{kl}}{\partial \mathbf{w}_{ij}}$$

CONVOLUTIONAL OPERATION

$$\leftarrow \frac{\partial L}{\partial \mathbf{y}}$$

\mathbf{x}_{11}	\mathbf{x}_{12}	\mathbf{x}_{13}
\mathbf{x}_{21}	\mathbf{x}_{22}	\mathbf{x}_{23}
\mathbf{x}_{31}	\mathbf{x}_{32}	\mathbf{x}_{33}

\mathbf{w}_{11}	\mathbf{w}_{12}	\mathbf{w}_{13}
\mathbf{w}_{21}	\mathbf{w}_{22}	\mathbf{w}_{23}
\mathbf{w}_{31}	\mathbf{w}_{32}	\mathbf{w}_{33}

\mathbf{y}_{11}	\mathbf{y}_{12}	\mathbf{y}_{13}
\mathbf{y}_{21}	\mathbf{y}_{22}	\mathbf{y}_{23}
\mathbf{y}_{31}	\mathbf{y}_{32}	\mathbf{y}_{33}

L_{11}	L_{12}	L_{13}
L_{21}	L_{22}	L_{23}
L_{31}	L_{32}	L_{33}

$$\mathbf{y}_{11} = \mathbf{w}_{11}\mathbf{x}_{00} + \dots + \mathbf{w}_{33}\mathbf{x}_{22}$$

$$\mathbf{y}_{12} = \mathbf{w}_{11}\mathbf{x}_{01} + \dots + \mathbf{w}_{33}\mathbf{x}_{23}$$

$$\mathbf{y}_{22} = \mathbf{w}_{11}\mathbf{x}_{11} + \dots + \mathbf{w}_{33}\mathbf{x}_{33}$$

$$\mathbf{y}_{33} = \mathbf{w}_{11}\mathbf{x}_{22} + \dots + \mathbf{w}_{33}\mathbf{x}_{44}$$

$$\frac{\partial \mathbf{y}_{11}}{\partial \mathbf{w}_{22}} = \mathbf{x}_{11}$$

$$\frac{\partial \mathbf{y}_{12}}{\partial \mathbf{w}_{22}} = \mathbf{x}_{12}$$

$$\frac{\partial \mathbf{y}_{33}}{\partial \mathbf{w}_{22}} = \mathbf{x}_{33}$$

$$\frac{\partial L}{\partial \mathbf{y}_{11}} \frac{\partial \mathbf{y}_{11}}{\partial \mathbf{w}_{22}} = L_{11}\mathbf{x}_{11}$$

$$\frac{\partial L}{\partial \mathbf{y}_{12}} \frac{\partial \mathbf{y}_{12}}{\partial \mathbf{w}_{22}} = L_{12}\mathbf{x}_{12}$$

$$\frac{\partial L}{\partial \mathbf{y}_{33}} \frac{\partial \mathbf{y}_{33}}{\partial \mathbf{w}_{22}} = L_{33}\mathbf{x}_{33}$$

$$\frac{\partial L}{\partial \mathbf{w}_{ij}} = \sum_k \sum_l \frac{\partial L}{\partial \mathbf{y}_{kl}} \frac{\partial \mathbf{y}_{kl}}{\partial \mathbf{w}_{ij}}$$

CONVOLUTIONAL OPERATION

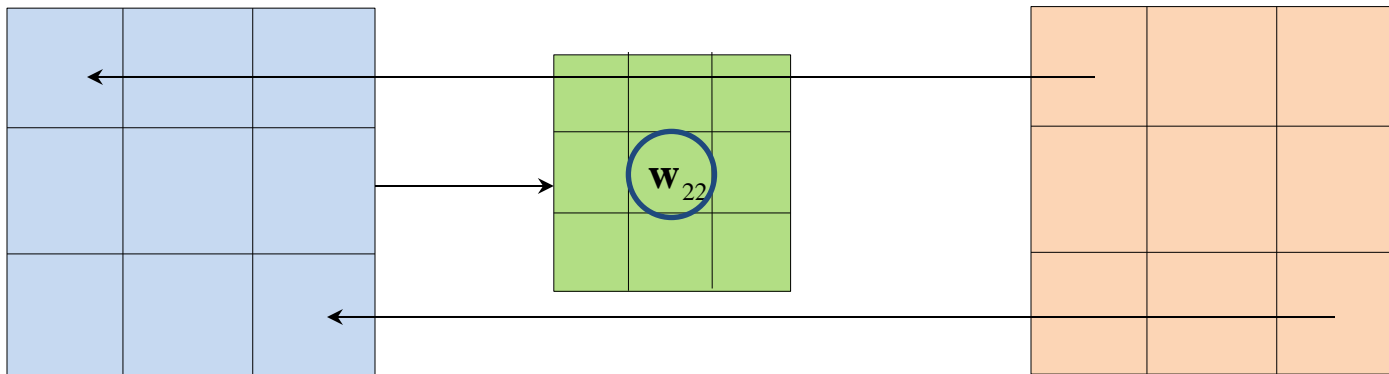

$$\frac{\partial L}{\partial \mathbf{y}_{11}} \frac{\partial \mathbf{y}_{11}}{\partial \mathbf{w}_{22}} = L_{11} \mathbf{x}_{11}$$

...

$$\frac{\partial L}{\partial \mathbf{w}_{ij}} = \sum_k \sum_l L_{ij} \mathbf{x}_{k+i, l+j}$$

$$\frac{\partial L}{\partial \mathbf{y}_{33}} \frac{\partial \mathbf{y}_{33}}{\partial \mathbf{w}_{22}} = L_{33} \mathbf{x}_{33}$$

CONVOLUTIONAL OPERATION

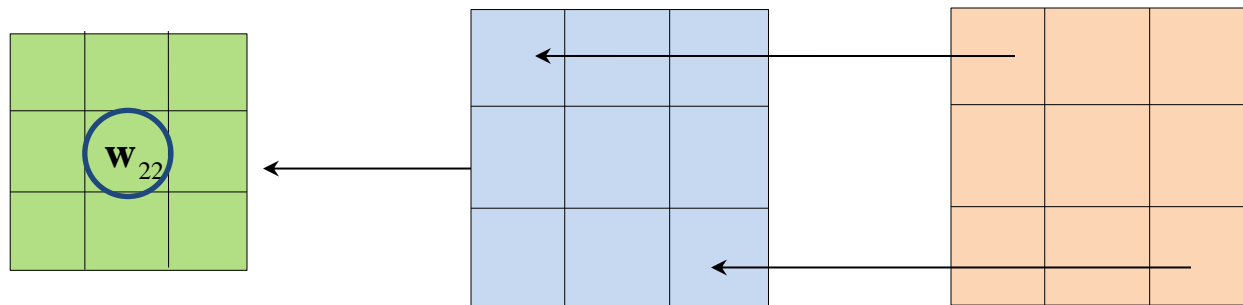

$$\frac{\partial L}{\partial \mathbf{y}_{11}} \frac{\partial \mathbf{y}_{11}}{\partial \mathbf{w}_{22}} = L_{11} \mathbf{x}_{11}$$

...

$$\frac{\partial L}{\partial \mathbf{w}_{ij}} = \sum_k \sum_l L_{ij} \mathbf{x}_{k+i, l+j}$$

$$\frac{\partial L}{\partial \mathbf{y}_{33}} \frac{\partial \mathbf{y}_{33}}{\partial \mathbf{w}_{22}} = L_{33} \mathbf{x}_{33}$$

CONVOLUTIONAL OPERATION

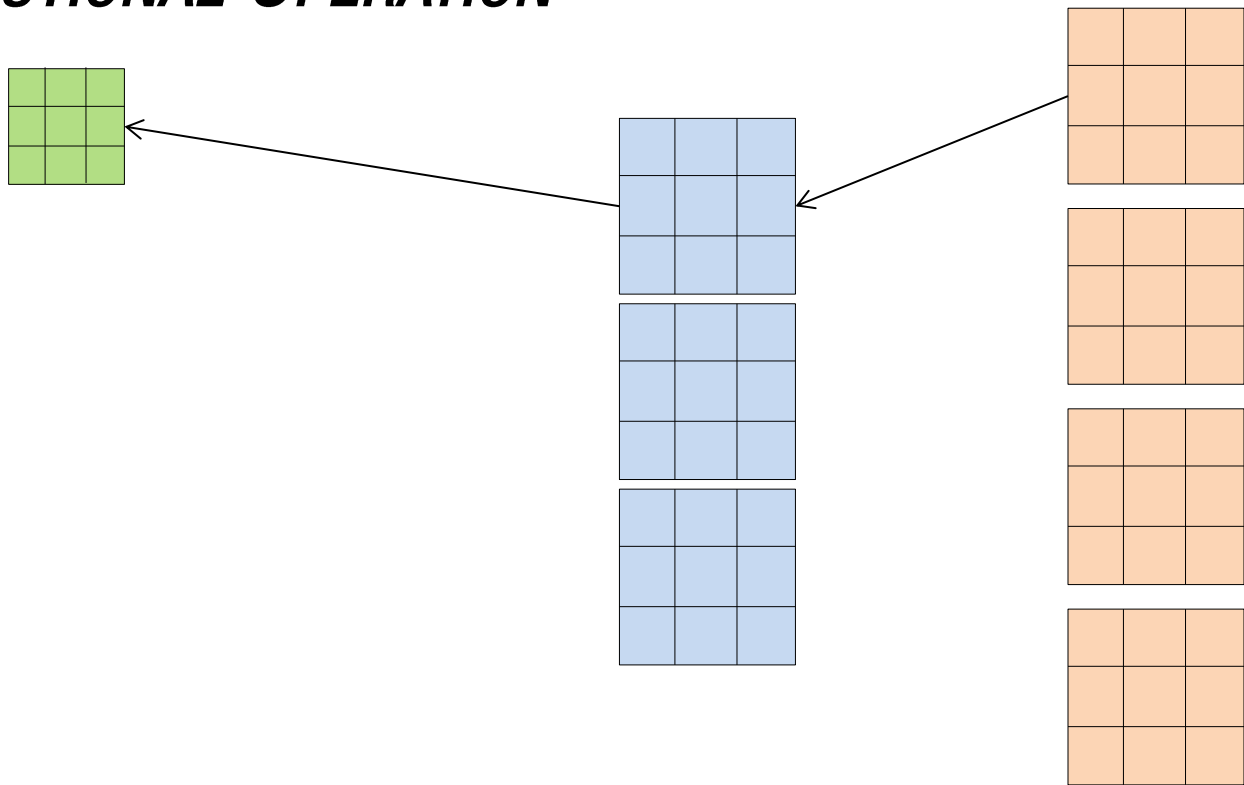

$$\frac{\partial L}{\partial \mathbf{w}_{ijcd}} = \sum_k \sum_l L_{kld} \mathbf{x}_{k+i,l+j,c}$$

CONVOLUTIONAL OPERATION

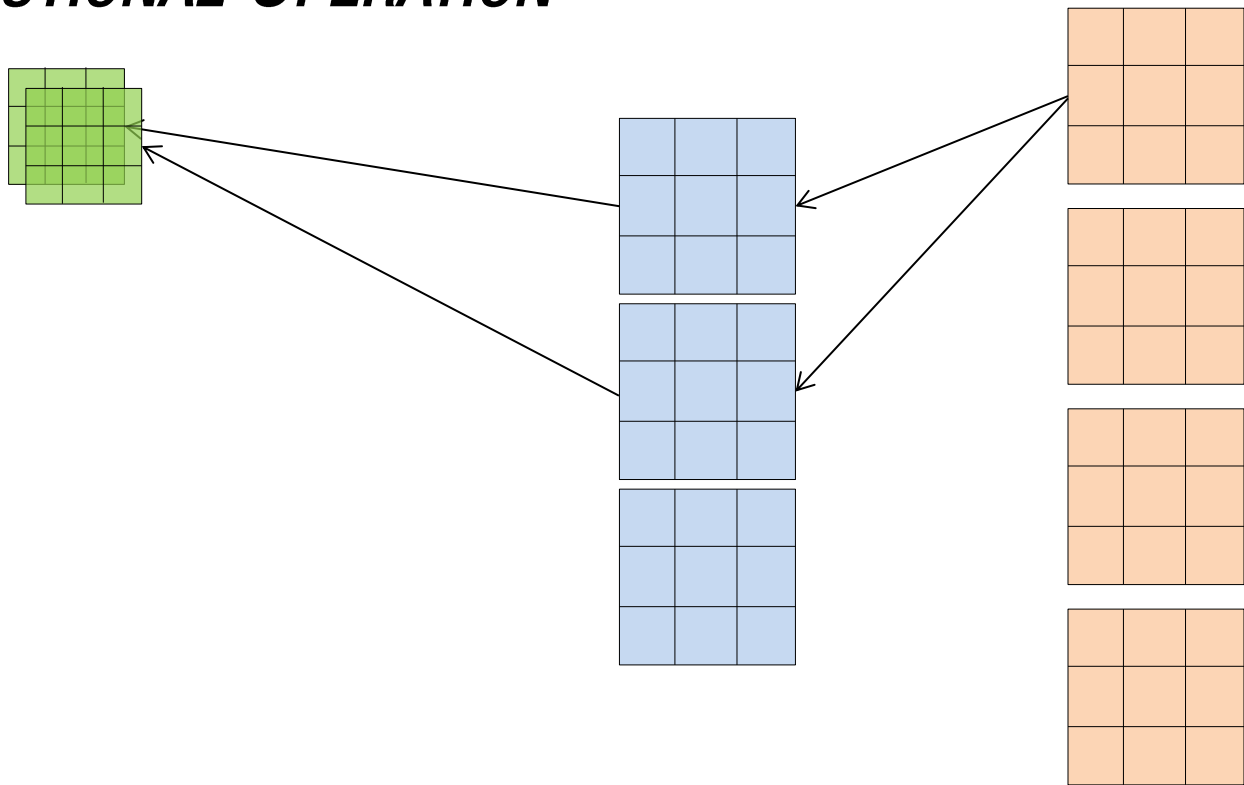

$$\frac{\partial L}{\partial \mathbf{w}_{ijcd}} = \sum_k \sum_l L_{kld} \mathbf{x}_{k+i,l+j,c}$$

CONVOLUTIONAL OPERATION

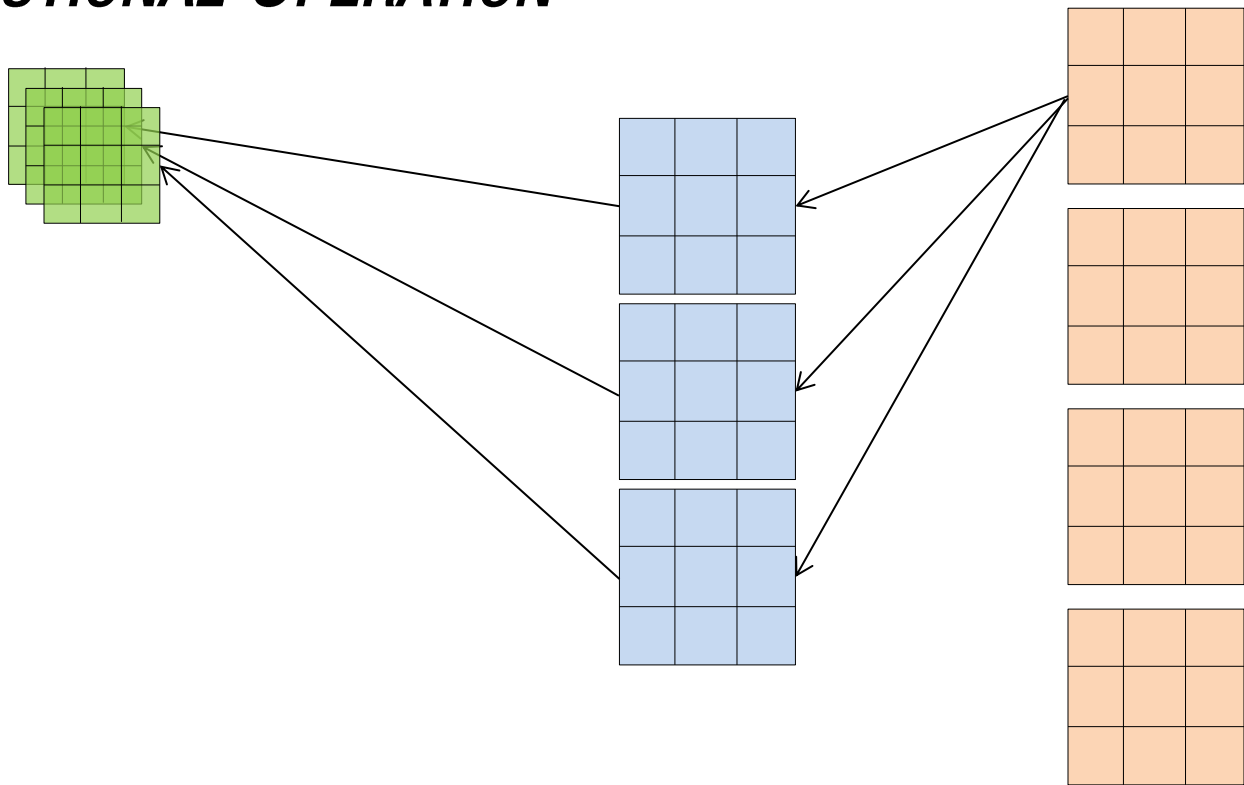

$$\frac{\partial L}{\partial \mathbf{w}_{ijcd}} = \sum_k \sum_l L_{kld} \mathbf{x}_{k+i,l+j,c}$$

CONVOLUTIONAL OPERATION

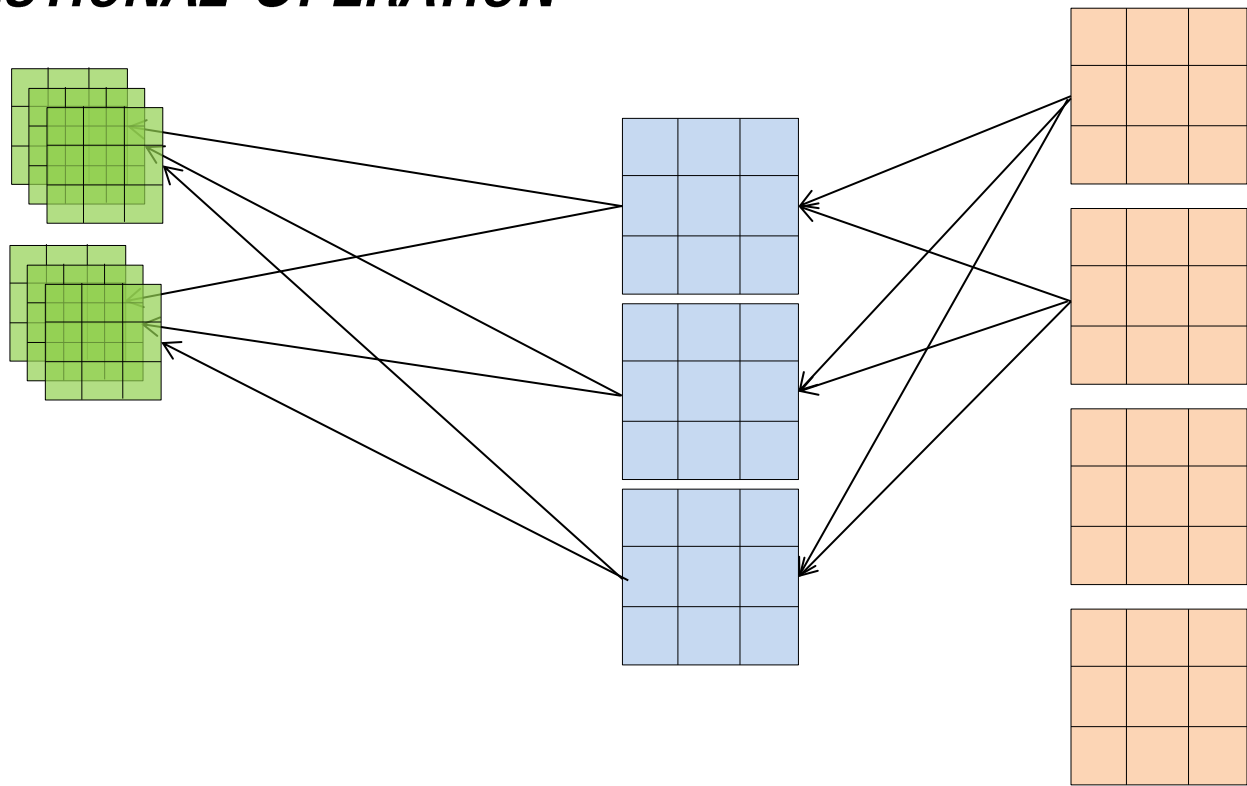

$$\frac{\partial L}{\partial \mathbf{w}_{ijcd}} = \sum_k \sum_l L_{kld} \mathbf{x}_{k+i,l+j,c}$$

CONVOLUTIONAL OPERATION

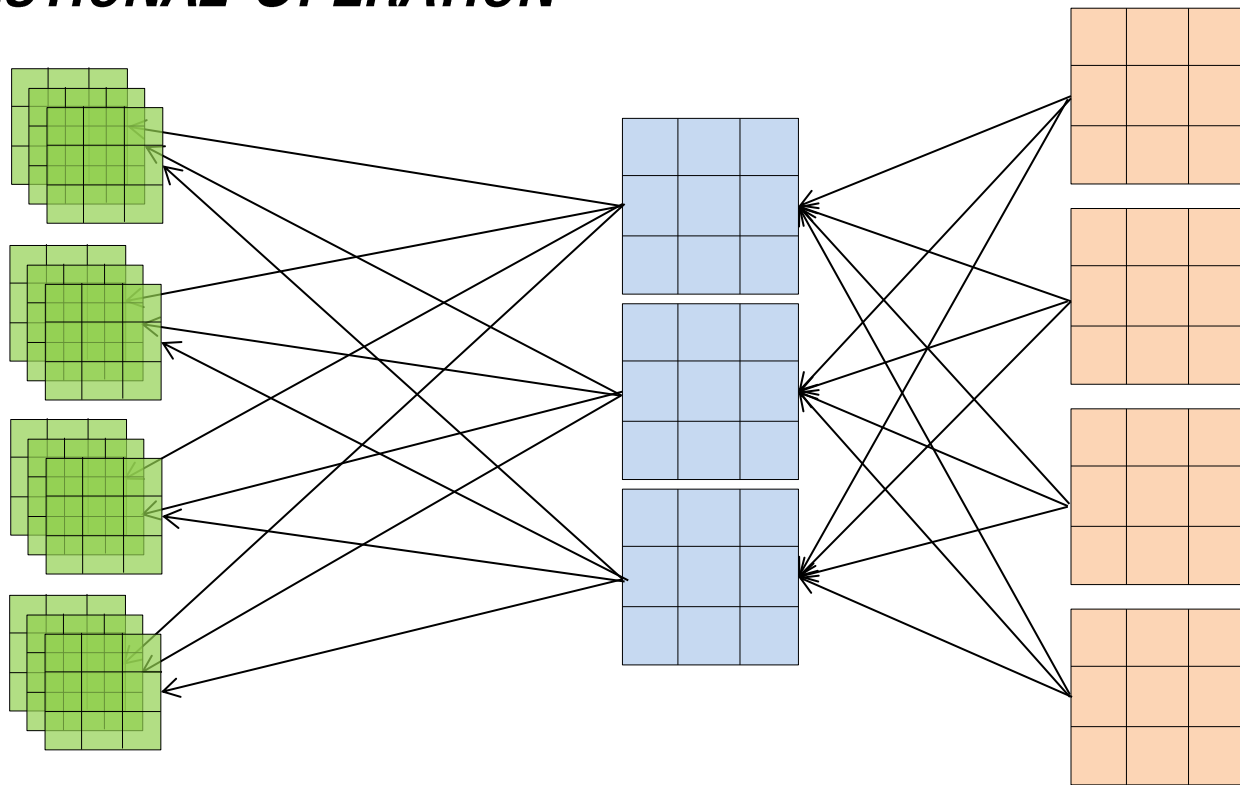

$$\frac{\partial L}{\partial \mathbf{w}_{ijcd}} = \sum_k \sum_l L_{kld} \mathbf{x}_{k+i,l+j,c}$$

CONVOLUTIONAL OPERATION

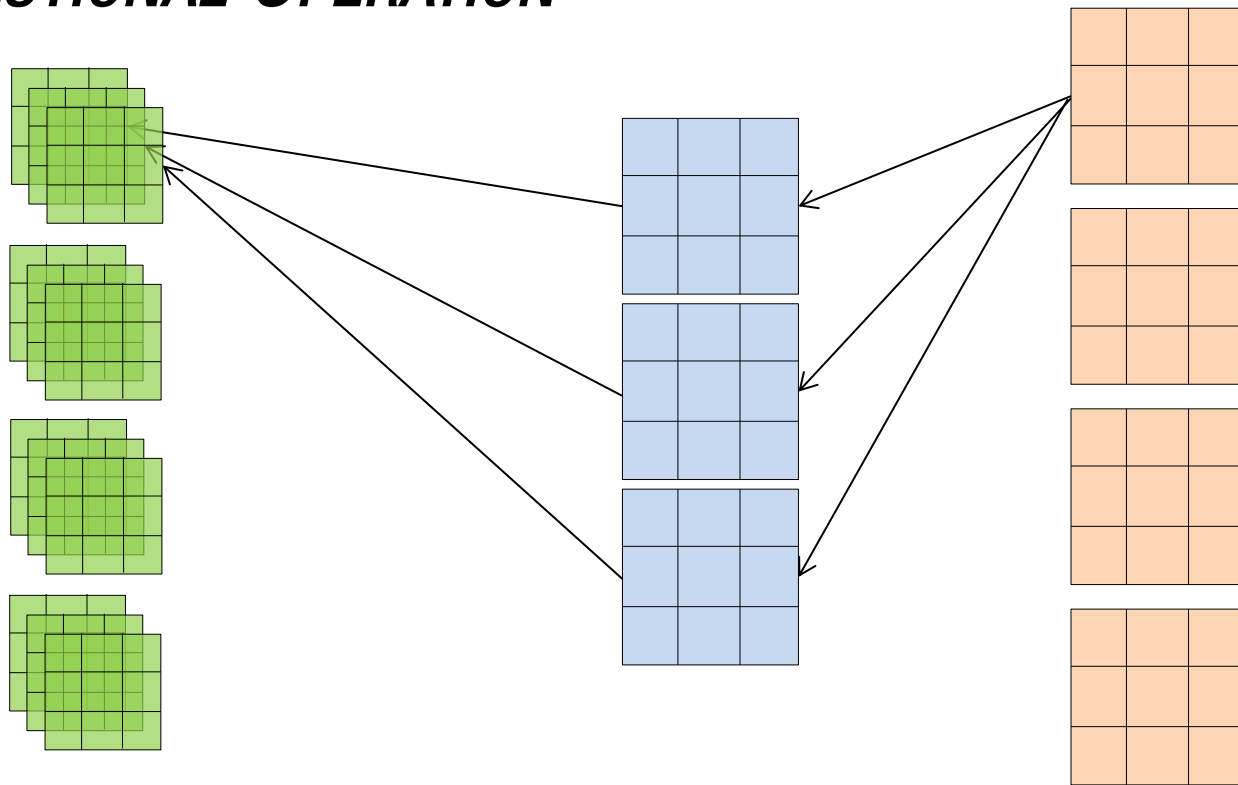

$$\frac{\partial L}{\partial \mathbf{w}_{ijcd}} = \sum_k \sum_l L_{kld} \mathbf{x}_{k+i,l+j,c}$$

CONVOLUTIONAL OPERATION

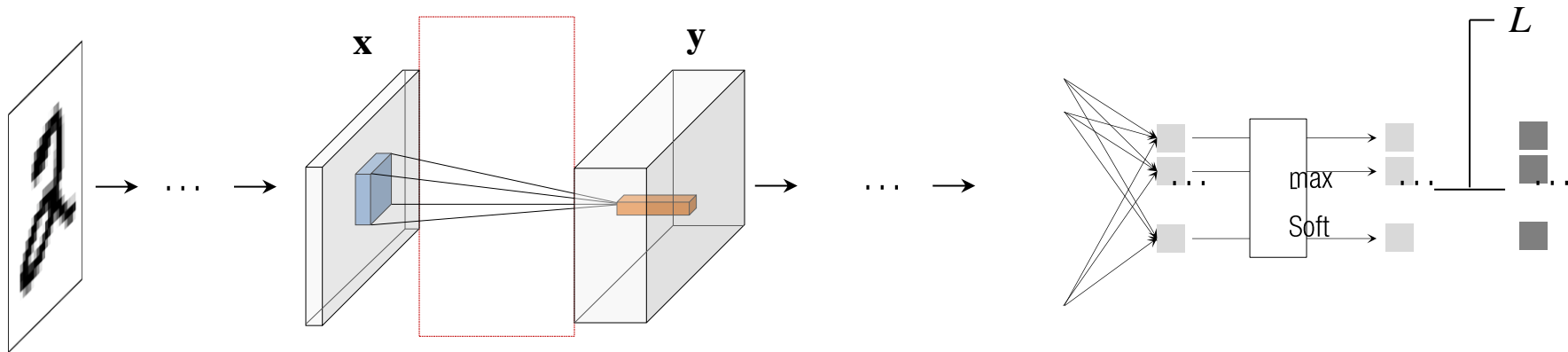

Input: $\mathbf{x} \in \mathbb{R}^{H \times W \times C_1}$

$$\frac{\partial L}{\partial \mathbf{x}_{ijk}} = \sum_m \sum_n \sum_l L_{mnl} \mathbf{w}_{m-i, n-j, k, l}$$

Trainable var.: $\mathbf{w} \in \mathbb{R}^{F \times F \times C_1 \times C_2}$

$$\frac{\partial L}{\partial \mathbf{w}_{ijcd}} = \sum_k \sum_l L_{kld} \mathbf{x}_{k+i, l+j, c}$$

Output: $\mathbf{y} = \mathbf{x} * \mathbf{w}$
 $\mathbf{y} \in \mathbb{R}^{H \times W \times C_2}$

function $[y] = \text{Conv}(x, w, b)$
 function $[dLdx \ dLdw \ dLdb] = \text{Conv_back}(dLdy, x, w, b, y)$

IM2COL

3	2	3	1
0	5	3	4
1	2	2	2
7	3	1	7

im2col
→

Im2Col

3	2	3	1
0	5	3	4
1	2	2	2
7	3	1	7

`Im2col(A, [2,2], 'distinct')`



3
0
2
5

Im2Col

3	2	3	1
0	5	3	4
1	2	2	2
7	3	1	7

`Im2col(A, [2,2], 'distinct')`



3 0
0 1
2 5
5 2

Im2Col

3	2	3	1
0	5	3	4
1	2	2	2
7	3	1	7

Im2col(A, [2,2], 'distinct')



3 0 1
0 1 7
2 5 2
5 2 3

Im2Col

3	2	3	1
0	5	3	4
1	2	2	2
7	3	1	7

`Im2col(A, [2,2], 'distinct')`



3	0	1	2
0	1	7	5
2	5	2	3
5	2	3	3

...

CONVOLUTION VIA IM2COL (DERIVATIVE W.R.T. W)

$$\begin{array}{c} \mathbf{w} \\ \begin{array}{|c|c|c|} \hline & & \\ \hline & & \\ \hline & & \\ \hline \end{array} \end{array} * \begin{array}{c} \mathbf{x} \\ \begin{array}{|c|c|c|c|} \hline 3 & 2 & 3 & 1 \\ \hline 0 & 5 & 3 & 4 \\ \hline 1 & 2 & 2 & 2 \\ \hline 7 & 3 & 1 & 7 \\ \hline \end{array} \end{array} = \mathbf{y}$$

$$\begin{array}{c} \mathbf{w} \\ \begin{array}{|c|} \hline \\ \hline \end{array} \end{array} \begin{array}{c} \mathbf{X} \\ \left[\begin{array}{cccc} 3 & 0 & 1 & 2 \\ 0 & 1 & 7 & 5 \\ 2 & 5 & 2 & 3 \\ 5 & 2 & 3 & 3 \end{array} \dots \right] \end{array} = \mathbf{Y}$$

CONVOLUTION VIA IM2COL (DERIVATIVE W.R.T. W)

w

*

x

3	2	3	1
0	5	3	4
1	2	2	2
7	3	1	7

= **y**

$$\frac{\partial L}{\partial \mathbf{w}_{ij}} = \sum_k \sum_l \frac{\partial L}{\partial \mathbf{y}_{kl}} \frac{\partial \mathbf{y}_{kl}}{\partial \mathbf{w}_{ij}}$$

w

--	--	--	--	--

X

3	0	1	2	...
0	1	7	5	...
2	5	2	3	...
5	2	3	3	...

= **Y**

CONVOLUTION VIA IM2COL (DERIVATIVE W.R.T. W)

$$\begin{array}{c} \mathbf{w} \\ \begin{array}{|c|c|c|} \hline \square & \square & \square \\ \hline \square & \square & \square \\ \hline \square & \square & \square \\ \hline \end{array} \end{array} * \begin{array}{c} \mathbf{x} \\ \begin{array}{|c|c|c|c|} \hline 3 & 2 & 3 & 1 \\ \hline 0 & 5 & 3 & 4 \\ \hline 1 & 2 & 2 & 2 \\ \hline 7 & 3 & 1 & 7 \\ \hline \end{array} \end{array} = \mathbf{y}$$

$$\frac{\partial L}{\partial \mathbf{w}_{ij}} = \sum_k \sum_l \frac{\partial L}{\partial \mathbf{y}_{kl}} \frac{\partial \mathbf{y}_{kl}}{\partial \mathbf{w}_{ij}}$$



$$\begin{array}{c} \mathbf{w} \\ \begin{array}{|c|} \hline \square \\ \hline \end{array} \end{array} \begin{array}{c} \mathbf{X} \\ \left[\begin{array}{cccc} 3 & 0 & 1 & 2 \\ 0 & 1 & 7 & 5 \\ 2 & 5 & 2 & 3 \\ 5 & 2 & 3 & 3 \end{array} \dots \right] \end{array} = \mathbf{Y}$$

CONVOLUTION VIA IM2COL (DERIVATIVE W.R.T. W)

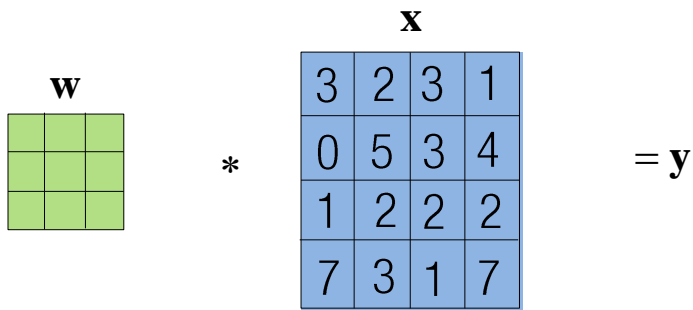

$$\frac{\partial L}{\partial \mathbf{w}_{ij}} = \sum_k \sum_l \frac{\partial L}{\partial \mathbf{y}_{kl}} \frac{\partial \mathbf{y}_{kl}}{\partial \mathbf{w}_{ij}}$$

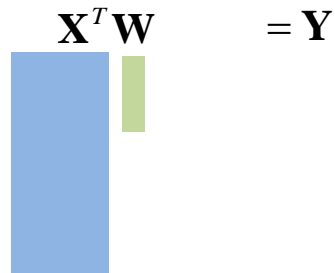

CONVOLUTION VIA IM2COL (DERIVATIVE W.R.T. W)

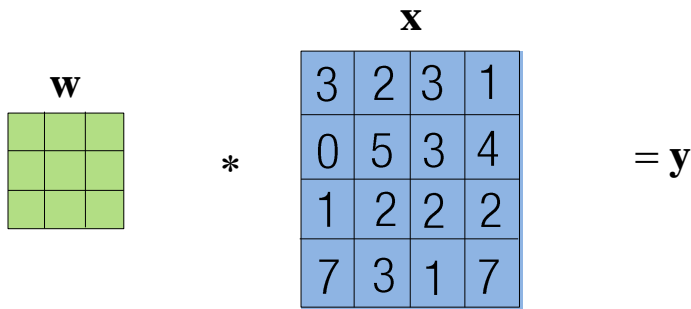

$$\frac{\partial L}{\partial \mathbf{w}_{ij}} = \sum_k \sum_l \frac{\partial L}{\partial \mathbf{y}_{kl}} \frac{\partial \mathbf{y}_{kl}}{\partial \mathbf{w}_{ij}}$$

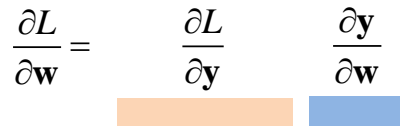
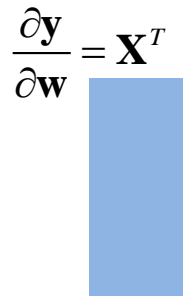
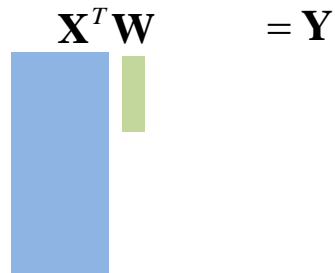

CONVOLUTION VIA IM2COL (DERIVATIVE W.R.T. \mathbf{X})

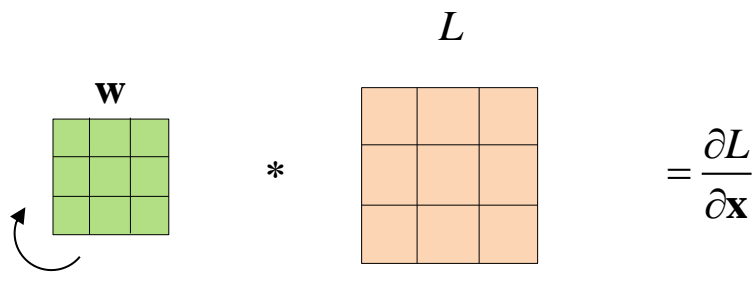
$$w * L = \frac{\partial L}{\partial \mathbf{x}}$$
$$\frac{\partial L}{\partial \mathbf{x}_{ij}} = \sum_k \sum_l L_{ij} \mathbf{w}_{i-k, j-l}$$

Reverse order

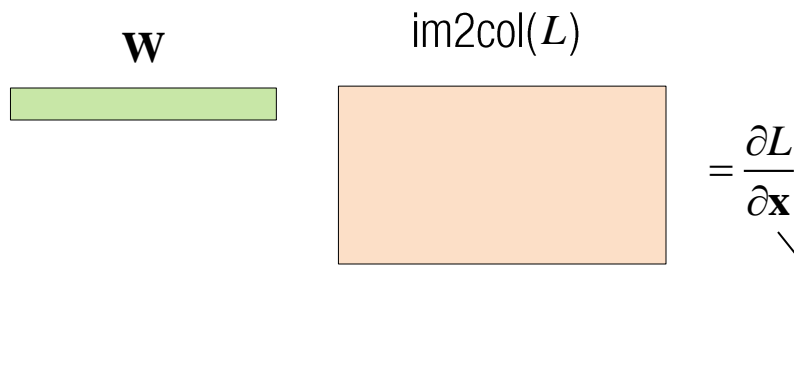
$$w * \text{im2col}(L) = \frac{\partial L}{\partial \mathbf{x}}$$

Row version of $dLdx$

SUMMARY

Forward prediction

```
pred1 = conv(x, w1)
pred2 = relu(pred1)
pred3 = pool(pred2)
```

```
pred10 = flatten(pred9)
pred11 = fc(pred10, w10)
```

```
pred16 = loss_ce_sm(pred15, label)
```

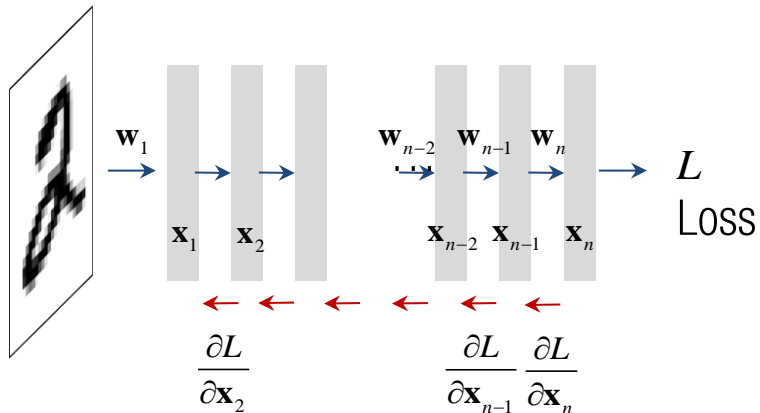

```
function [dLdx dLdy] = foo_back(dL, x, y)
```

SUMMARY

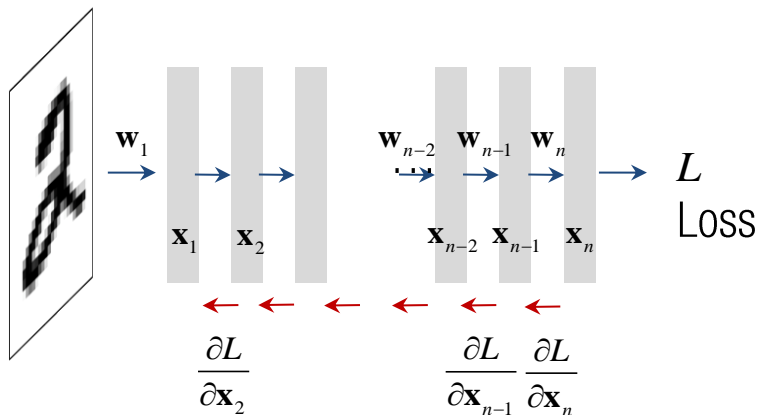

function [dLdx dLdy] = foo_back(dL, x, y)

Forward prediction

pred1 = conv(x, w1)
pred2 = relu(pred1)
pred3 = pool(pred2)

pred10 = flatten(pred9)
pred11 = fc(pred10, w10)

pred16 = loss_ce_sm(pred15, label)

Back-propagation

dLdx = loss_ce_back(pred15, label)

dLdx, dLdw10 = fc_back(pred10, w10, pred11)
dLdx = flatten_back(dLdx, pred9, pred10)

dLdx = pool_back(dLdx, pred2, pred3)
dLdx = relu_back(dLdx, pred1, pred2)
dLdx, dLdw1 = conv_back(dLdx, x, w1, pred1)